

服务热线:400-811-7600

创新是解决
难题的金钥匙!

有了好工具
再难干的事
也变得简单了



官方网站



公众号

MAXPOWER



MAXPOWER[®] 迈凯思



——工具方案解决商——
www.cw-maxpower.com

中国五金工具 领军企业

威海市力钰实业有限公司
文登威力工具集团有限公司
地址:山东省威海市文登经济开发区惠州路8号
电话:0631-3587857 3587779
传真:0631-3587661
邮编:264200

Weihai Liyu Industry Co.,Ltd.
Wendeng Maxpower Tool Group Co.,Ltd.
Add :No.8 Huizhou Road,Wendeng Economic Development Zone,
Weihai City,Shandong Province
Tel : 0086-631-3587857 3587779
Fax : 0086-631-3587661

2023

公司/简介



威海市力钺实业有限公司控股中国五金工具龙头企业--文登威力工具集团有限公司。公司占地面积75万平米,拥有五金工具行业国家认定技术中心和国际认可CNAS认证实验室,是中国制造业单项冠军示范企业、中国五金标委会成员单位,主持和参与制修订国家标准120多项,获得“中国五金工具十大著名企业”、首届山东省“厚道鲁商”等荣誉称号。

近六十年的发展历程,企业始终致力于五金工具的研发与生产,为中国五金工具行业的发展和民族工业的振兴做着不懈的努力。五金工具生产流程涵盖锻造、机械加工、热处理、表面处理和组装装配、包装等工序,制造工艺涵盖面广,工序多需严细管理。因此,企业严格实行AAAAA标准化模式和管理体系。自上世纪九十年代起,先后通过ISO9001质量体系认证、ISO14001环境管理体系、OHSAS18001职业健康安全管理体系认证以及日本JIS、德国VPA/GS、韩国KS等产品认证,产品抢占国际高端市场,享有盛誉。全球注册的“MAXPOWER”获得中国驰名商标,产品销往欧、美、亚、非洲等80多个国家和地区。

“以创新为先导,引导消费;以消费为导向,持续改进,打造消费者满意品牌,振兴中国民族工业,让中国创造为全球制造服务”,是企业一直秉承的理念和宗旨。

Introduction

Weihai Liyu Industrial Co., Ltd. holds the leading hardware tool manufacturer in China, Wendeng Maxpower Tool Group Co., Ltd. The company covers an area of 750,000 square meters. Maxpower owns a national-level technology center and internationally-recognized CNAS certificated laboratory in the hardware tools industry. It is also a unit champion in China's manufacturing industry and a member of the China Hardware Standards Committee. Maxpower chairs and participates in the revision of more than 120 national standards. It also won "China's Top Ten Famous Hardware Tool Company", the first Shandong Province "Honest Lushang" and other honorary titles.

Over the past 60 years of development, the company has always been committed to the development and production of hardware tools, and has made unremitting efforts for the development of China's hardware tools industry and the revitalization of national industries. The hardware tool production process covers processes such as forging, machining, heat treatment, surface treatment, assembly, and packaging. The manufacturing process covers a wide range of processes and more processes are required to be managed in detail. Therefore, the company strictly implements the AAAAA standardization model and management system. Since the 1990s, it has successively passed ISO9001 quality system certification, ISO14001 environmental management system, OHSAS18001 occupational health and safety management system certification, and Japan JIS, Germany VPA/GS, Korea KS and other product certifications, and its products have become prestigious in capturing high-end international markets. The globally registered "MAXPOWER" brand has been awarded a well-known trademark in China and its products have been sold to more than 80 countries and regions including Europe, America, Asia, and Africa.

"Taking innovation as the forerunner, guiding consumption, continuing to improve with consumption, building consumer satisfaction brands, revitalizing China's national industry, and making Chinese manufacturing a global manufacturing service," This is the company's concept and purpose.



1968

文登县五金厂成立。
Wendeng County Hardware
Factory was built.



1976

开始通过外贸公司出口，
走入国际化发展道路。
Since 1976 Maxpower started
to export to the international market
through trading companies.



1988

拥有自营进出口权；厂区面积第一次扩张，由原来4万平方
米扩展到25万平方米。

Obtained the right to import and export.
The first expansion of the factory area, from the original 40,000
square meters to 250,000 square meters.



1998

体制改为股份制公司，使企业重新注入了活力，
步入了发展的快车道。

In 1998, Maxpower was restructured to a joint-stock
company. Then Maxpower started her fast development.



1996

全国同行业早期通过ISO9001质量保证体系认证，随后相
继通过了ISO1400环境管理体系认证、OHSAS1800职业健康安
全管理体系认证以及VPA/GS认证、KS认证、JIS等产品认证。

In 1996, Maxpower achieved the ISO9001 Quality System
Certificate and was the first company in the Chinese Hand tools
field to do so. Maxpower also achieved the ISO14000 environ-
ment management system certificate as well as the OHSAS1800
Certificate. The VPA/GS, KS, JIS production certificate were also
gained thereafter.



2009

在国外80多个国家注册并销售的“MAXPOWER”工业级品
牌开始在国内运作。

In 2009, MAXPOWER brand with industrial quality started to
be sold in Chinese Domestic Market. Before this time, Maxpower
brand was already registered and sold in over 80 countries.



2012

被国家发展改革委、科技部、
财政部、海关总署、国家税务
总局联合授予“国家认定企业
技术中心”。
是中国五金工具行业唯一获此
殊荣企业。



In 2012, the China Development and Reform Commission,
Ministry of Science, Ministry of Finance, General Administration of
Customs and State Administration of Taxation acknowledged
Maxpower's National Enterprise Technology Center.

Maxpower is the sole company in China's hardware and hand
tools field to possess this achievement.

2017

获得国际认可实验室CNAS评审。
In 2017, it was accredited by the
national accredited laboratory CNAS.



2019

荣获国家技术创新示范企业称号
In 2019, Won the title of National Technology
Innovation Demonstration Enterprise.



2020

设立韩国工厂生产基地
In 2020, Set up a South Korean factory production base.

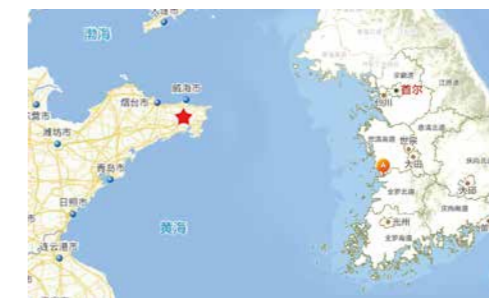

2021

荣获国家级工业设计中心称号

In 2021, Won the title of National Industrial Design Center



2014

“MAXPOWER”商标于
2014年9月，被国家工商总局
认定为中国驰名商标。



In September 2014, Maxpower brand was recognized as
a well-known trademark by the Chinese State Administration
for Industry and Commerce.

2018

获得“国家制造业单项冠军示范企业”荣誉
工具五金分会会长单位

In 2018, it was honored as “Individual champion
model of manufacturing enterprises”.

Hardware Tool Branch President Company



品牌源于积淀

五十多年专注一件事

只做好工具

BRAND ORIGINATED FROM ACCUMULATION

Focus on one thing for fifty years

— only for the best tools

几代人坚持一个梦想

Generations insist on a dream

每年发明专利15项以上
参与制修订标准100多项
平均每个工作日一个新产品
或专利产品诞生
More than 15 invention patents per year
Participated in the production of more than 100 revised standards
An average of one new product or patented product is born every day.

公司拥有
检测设备160台(套)
生产设备5200多台(套)
More than 160 testing equipment
More than 5,200 production equipment

倡导创新文化
实施创新行动
把创新当成企业
发展之魂
Advocating innovation culture
Implement innovative actions
Making innovation as the soul
of enterprise development.

匠

严把进料关
每批次做到可追溯性

Strictly control the feed,
traceability achieved for every batch.

创新是企业的灵魂
每一位员工都是“金点子”大王

Innovation is the soul of the company.
Every employee is the "golden idea" king.

拥有国家认定企业技术中心、CNAS国家认可实验室
省级工程技术研究中心院士工作站
National Enterprise Technology Center
CNAS National Laboratory
Provincial Engineering Technology Research Center
Academician workstation

通过质量管理体系、职业健康安全体系、环境管理体系认证
通过韩国K、日本JIS、泰山品质、
德国VDA/ISO等产证认证
Passed the quality system, occupational health and safety system, environmental management system certification. Passed Korean K, Japanese JIS, Taishan quality, German VDA/ISO and other product certification.

关键工序重点防控
落实6σ质量管理

Key process key prevention and control
Implement 6σ quality management

IE精益TPA逐步推进
提升车间生产效率

IE lean TPA gradually promoted
Improve workshop productivity

作业标准化
改善习惯化
提升常态化

Job standardization Habit improvement Normalize upgrade

质量之魂 存于匠心



集团总部
Group headquarters



开发区厂区
Development Zone Factory



威海临港新区厂区
Weihai Lingang New District Factory

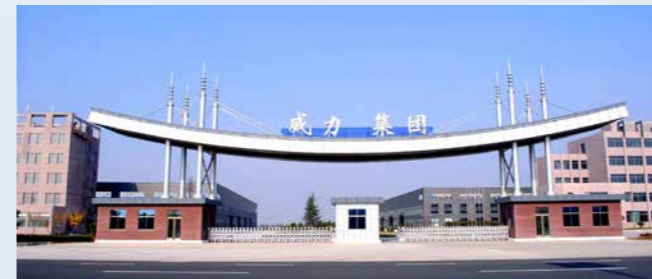

南海新区环保设备厂区
Nanhai New District Environmental Protection Equipment Factory



威力风机厂区
Maxpower Fan Factory



韩国厂区
Maxpower Korean Factory

荣誉资质



▲ 扭转试验机 [10000N.m] (行业首台)
▲ Torsion testing machine [10000N.m] (First in the industry)



▲ 金属试样切割机
▲ Metal specimen cutting machine



▲ 电子弹簧拉压试验机
▲ Electronic spring pulling and pressing tester

检测中心

Testing Center



▲ 剪刀寿命测试机
▲ Scissor life testers



▲ 显微维氏硬度计
▲ Micro Vickers hardness tester



▲ 液压式万能试验机
▲ Hydraulic universal testing machine



▲ 万能工具显微镜
▲ Universal tool microscope



▲ 多元素自动分析仪
▲ Multi-element automatic analyzer



▲ 金相显微镜
▲ Metallographic microscope



▲ 红外碳硫分析仪
▲ Infrared carbon and sulfur analyzer



▲ 破裂强度试验机
▲ Rupture strength tester



▲ 扭矩测试仪
▲ Torque Tester



▲ 洛氏硬度计
▲ Rockwell hardness tester



▲ 耐高压试验机
▲ High pressure resistance tester



▲ 光学影像测量仪
▲ Optical Image Measuring Instrument



▲ 扭力寿命试验机
▲ Torque experiment life machine



▲ 电镀盐雾测试仪
▲ Electroplating salt spray tester



▲ 直读光谱分析仪
▲ Direct reading spectral analyzer



▲ 气相色谱质谱联用仪
▲ Gas Chromatography Mass Spectrometer

创新 Innovation

我们依托国家认定企业技术中心、高新技术企业、CNAS国家认可实验室、院士工作站、省级工程技术研究中心，不断加强产品研发和成果转化，并积极开展与高校、科研院所等的产学研企合作，为公司的持续技术创新打造了强大的外部创新平台。

We work with nation-level enterprise technology centers, high-tech enterprises, CNAS national accredited laboratories, academicians workstations, provincial engineering technology research centers, constantly strengthen our product development and results transformation. We cooperate with universities, research institutes and other enterprises to create sustainable technology innovation for our company. This has created a strong external innovation platform for the company's continuous technological innovation.

在内部管理运行上，我们制定了“树立智能制造文化，打造百年长青企业”的强企战略，组建了生产和工程技术两个团队，统筹调配所有资源，实现两大引擎双轮驱动企业创新，打造智能制造工厂。

In terms of internal management and operation, we have formulated a strong enterprise strategy of "building a smart manufacturing culture and building a 100-year-old evergreen enterprise". We have established two teams of production and engineering technology to coordinate all resources to achieve dual-engine dual-wheel drive enterprise innovation and build a smart manufacturing factory.



工具方案 解决商 Tool solution provider

创新离不开有创意的金点子，我们依靠3种途径获取创意：

- 第一种是我们自主设计独创的产品来引领市场；
- 第二种是客户提出对产品的新要求；
- 第三种是我们主动走向终端客户，收集创意点子，为客户解决问题。

Innovation is inseparable from creative ideas. We rely on 3 ways to get ideas:

- The first is that we independently design original products to lead the market;
- The second is the customer's new requirements for the product;
- The third is that we take the initiative to go to the end customers, collect ideas and solve problems for customers.

我们的愿景是和终端客户一起成长，做到**长效经营**，为客户打造**一站式**工具解决方案，按照精益思想为客户创造增值新亮点。

Our vision is to grow with end customers, achieve long-term operations, create one-stop tool solutions for customers, and create new value-added highlights for customers in accordance with lean thinking.

工具定制化方案会运用到每个细节，简洁高效、安全方便是我们的设计总原则，力求让工具随心所欲。

The tool customization program will apply to every detail. Concise, high-efficiency, safety, and convenience are our general design principles, and we strive to make the tool as you like.



个性化私人订制
手动、高效、智能组合
 Personalized private customization
 Manual, efficient, intelligent combination

以顾客为中心，勇于创新
坚守质量实现百年长青企业
 Customer-centric, innovative
 Adhere to quality and realize the century-old enterprise

“五小工”工具箱
空军军事设施建设局

中国武警
狙击步枪弹药箱

消防应急组
119

营连维修工具箱
军办机要局配发

S 个性化定制
Personalized customization

60多人的工程技术开发团队,满足不同行业、用途、效能提升的工具方案提供,让工具随心所动。
 More than 60 people in engineering and development teams to meet the needs of different industries, uses, and efficiency improvement tools, let the tools serve at will.

长效经营
Long-term operation



创新
Innovation
在每一个细节中
In every detail



社会责任
Social responsibility
在每一道工序中
In every process



- 针对要求 解决问题 Resolve the problem
- 符合标准 品牌保证 Meet the standard. Guaranteed by brand.
- 缩短生产交货周期 Shorten production lead times
- 精益求精 追求卓越 Strive for excellence
- 共享共赢 协调互进 Sharing and win-win

开展个性化定制, 柔性化生产, 提升使用者精益求精的工匠精神, MAXPOWER秉持高效、优质、创新和增值的服务理念, 与您一起共享共赢。
 Carry out personalized customization, flexible production, and enhance the spirit of craftsmanship of users. MAXPOWER adheres to the service concept of high efficiency, high quality, innovation and value-added, and shares win-win with you.

轨道交通 Rail

电子电工 Electronic and Electrical

能源行业 Energy Industry

石油作业 Oil Industry

机械制造 Machinery

汽保设备 Auto maintenance

智能 Intelligent

高效 Efficient

专业 Profession

创新
Innovation
企业之魂
Corporate soul



重汽组套
Heavy truck set



焊接工作台
Welding workbench

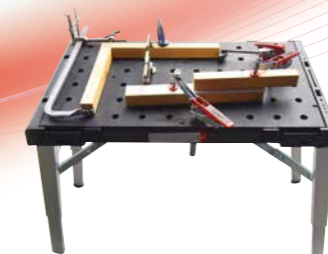

木工工作台
Woodworking workbench



钳工工作台
Fitter workbench

航空专业

Aviation Industry

- 操作平台
Operating platform
- 一锁多用 安全便捷
One lock for multiple uses
safe and convenient
- 多层工具收纳
取用方便
Multi-floor tools storage
easy to access
- 采用优质滚珠滑道
加长伸展距离
使抽屉100%拉开
High quality ball slides
with extended 100% pull-off reach
- 车轮双刹设计
稳固安全
Double brakes on wheels
for stability and safety



- 借出归还自动管理
Automatic management of lending and return
- 人员职务与权限管理
Management of staff positions and competencies
- 工具寿命与维护功能
Tool life and maintenance functions
- 工具追溯系统
Tool traceability system
- 自动盘点并记录
Automatic inventory and recording

电力行业/新能源汽车

Power industry / New energy vehicles

上盖采用模具一次成型技术
便于清洁 坚固耐用
The upper cover is one time mold
easy cleaning and strong durability

两侧的网孔板设计
拓展使用功能
Mesh panels on both sides
Multi use design

优质钢珠滑道
取用方便
High quality steel ball slide
easy to access

优质冷轧板及角铁加工而成
车体牢固 经久耐用
High quality cold rolled sheet and
angle iron processing to make the
vehicle solid and durable

车轮带锁功能
安全可靠
Wheel with lock function is
safe and reliable

★可按照客户需求对各类产品进行任意搭配
Customize for any hand tools inside to fulfils customer's requirements

- 定制类工具配置 模块化设计
Modular design for customize classic tool configuration
- 定向新能源汽车(混合动力/纯电动)维修
覆盖车型广配置齐全
Targeted new energy vehicle (hybrid/electric) maintenance covers a wide range
- 满足新能源汽车维修对工具的要求
Fulfill demands for new energy vehicle maintenance
- 全系列VDE绝缘 每支经耐高压测试 适用于电力行业
Full range of VDE sets, each product tested for high voltage resistance of the power industry

VDE
绝缘
维修
组套
Insulated maintenance set



定制化解决方案
Customized Solutions

一体维修维护工具组合
All-IN-ONE repair and maintenance tools set

铁路智能工具柜

Railway Intelligent Tool Cabinets



一键盘点功能
3秒实现日检及月检工作。
One keypad point function for daily and monthly checks in three seconds.

失落工具查找
可通过RFID手持终端进一步查找遗失工具。
Lost and found tools can be realized through RFID handheld terminals.

全自动管理
RFID工具进出记录管理，快！准！精确！并且系统可生成各种报告。
Fully automated management, fully automated tool entry and exit accurate records and system can generate report automatically.

数据安全
对读写器与RFID电子标签的数据交互进行加密，即使信号暴露在空气中也无法被窃取和修改。
Data security, the read-write and RFID electronic tag data interaction is encrypted even if the signal is exposed in the air, data cannot be stolen and modified.

安全保障，追责到人
当工具未按时归还时，工具车将会发出警告，快速锁定相关人员责任。
Safety and security with accountability, when tools are not returned in time the tool trolley will issue a warning and quickly lock out the person concerned.

数据采集，科学分析
工具参数数据记录，特定工具的标定周期提醒。
Data acquisition, scientific analysis, data logging of tool parameters tool-specific calibration intervals reminders.

无线网络连接
可以使用WIFI或者4G等网络连接。
Wireless internet connection such as WIFI/4G and so on.

存储量大
每个抽屉最大承重100KG。
Large storage capacity maximum 100kg per drawer.



工具智能存储系统

Intelligent storage system for tools



- 借出归还自动管理
Automatic management of lending and return
- 人员职务与权限管理
Management of staff positions and competencies
- 工具寿命与维护功能
Tool life and maintenance functions
- 工具追溯系统
Tool traceability system
- 自动盘点并记录
Automatic inventory and recording
- 可远程数据监控
Remote data monitoring



- 工具借用
Tools on loan
- 工具归还
return of tools
- 配置设备
Configuring equipment
- 人员管理
People Management
- 保修管理
Repair Management
- 控制管理
Control management
- 报警处理
Alarm Handling
- 设备信息
Equipment information



增值服务 — 实验室检测

文化与愿景

Culture & Vision



承担五金工具类产品的检测及出具检测报告

检测涵盖材料、硬度、扭矩、疲劳、寿命等测试内容



创新好工具
Innovate better tools
造福各行业
Increment value for all industries
愿景
Vision

工匠智选
Craftsman's Choice
品牌首选
Brand priority choice
目标
Objective











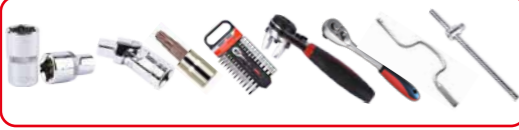

使命
Mission
提供高效智能
工具解决方案
成就客户
幸福员工
Achieve with customers
happy with employees

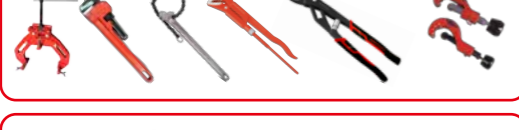

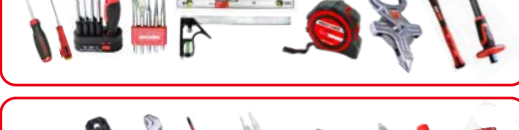
承诺
Commitment
至诚天下
绿色致远
Integrity and Sincerity
Environmentalists and Long-term partner

价值观
Value
感恩
奉献
跨越
Gratitude
Devotion
Surpass

工作作风
Attitude
迅速反应
立即行动
做就做好
Rapid Response
Immediate Action
Well done

01		综合组套、工具存储类 Tool Set and Tool Storage	P01-35
02		扳手类工具 Wrench	P36-54
03		手动套筒、附件类工具 Socket & Accessories	P55-68
04		气动类工具 Pneumatic Tools	P69-74
05		夹持类工具 Clamping Tools	P75-87
06		管道类工具 Plumbing Tools	P88-94
07		切割类工具 Cutting Tools	P95-103
08		旋具类工具 测量类工具 敲击类工具 Screwdriver Series / Measurement Tools / Striking Tools	P104-116
09		电子类、绝缘类工具 Electrical Tools / Insulation Type Tools	P117-131
10		汽保类工具 拉马类工具 液压综合工具 Automotive Products / Puller Tools / Hydraulic Tools	P132-141
11		园林类工具 焊割类工具 建筑装潢类工具 Garden Tools / Welding Tools / Building&Decorating Tools	P142-146
12		防爆类工具 Non-Sparking Brass Tools	P147-149
13		家居礼品类组套 Excellent Set Series For Home	P150-151

综合组套 / 工具存储类

Tool Set and Tool Storage

组套工具	2-17
套筒扳手套组	18-27
RFID智能工具箱	28
RFID智能移动四抽/七抽/八抽工具车	29-31
工具箱及工具车	32-34
工具包	34-35
Tool Set	2-17
Socket Accessories	18-27
RFID Delection Tool Box	28
RFID Delection 4/7/8 Drawer Rolling Tool Cabinet	29-31
Tool Bog & Tool Vehicle	32-34
Tool Bag	34-35



99件综合维修组套

99 pcs Complete Repair Tool Set



货号
M95075

▶ 适配合工具车M08207

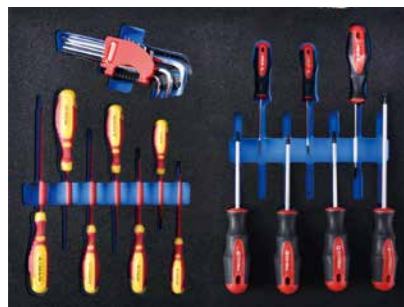

M95076



M95077



M95078



M95079



M95080

23件综合维修组套

23 pcs Complete Repair Tool Set

M95076

- 绝缘螺丝批 ● 一字3x100,4x100,5.5x125,6.5x150mm ◆ 十字PH0x75,PH1x100,PH2x100
- 双色柄花型螺丝批 ◆ T8x75, T10x75, T15x100, T20x100, T25x100, T27x100, T30x150
- 球头加长内六角扳手9PCS (1.5,2,2.5,3,4,5,6,8,10)
- 7pcs Insulated Screwdriver Slotted 3x100 4x100, 5.5x125, 6.5x150mm PH0x75, PH1x100, PH2x100
- 7pcs Bi-color handle Torx screwdriver T8x75, T10x75, T15x100, T20x100, T25x100, T27x100, T30x150
- 9pcs Long Arm Ball Point Hex Key Set (1.5, 2, 2.5, 3, 4, 5, 6, 8, 10)

30件综合维修组套

30 pcs Complete Repair Tool Set

M95077

- 精密螺丝批6件套 ● 一字1.4,2,2.4,3 ◆ 十字PH0, PH1
- 伸缩式反光镜
- 伸缩式捡拾器
- 吸锡器
- 30W电烙铁
- 汽车测电笔6-12-24V
- 1/4"系列套筒组套18PCS
- LED维修工作灯2x3W
- Accurate Screwdriver Set Slotted 1.4, 2, 2.4, 3 PH0,PH1
- 1pc Telescopic mirror
- 1pc Telescopic picker
- 1pc Solder sucker
- 1pc Soldering Iron 30W
- 1pc Voltage Tester 6-12-24V
- 18pcs.1/4"Dr.Socket Wrench Set
- 1pc LED portable worklight

12件综合维修组套

12 pcs Complete Repair Tool Set

M95078

- 8"钢丝钳
- 145mm电工剪
- 0.3kg钳工锤
- 注油器
- 毛刷
- 钻头(φ10mm)
- 7"穴直卡簧钳
- 7"轴直卡簧钳
- 6"绝缘剥线钳
- 6"尖嘴钳
- 6"斜嘴钳
- 6"电缆剪
- 1pc Combination Pliers 8"
- 1pc Electrician Scissors 5"
- 1pc Riveting Hammer With Wooden Handle
- 1pc Oil injector
- 1pc Brush
- 1pc Drill(φ10mm)
- 2pcs Snapping Pliers 7"
- 1pc Insulated Wire Stripping Pliers 6"
- 1pc Long Nose Pliers 6"
- 1pc Diagonal Cutting Pliers 6"
- 1pc Cable Cutter 6"

18件综合维修组套

18 pcs Complete Repair Tool Set

M95079

- 17pcs两用扳手:6, 7, 8, 9, 10,11,12,13,14,15,16,17,18,19,20,21,22 mm
- 8" 55型活扳手
- 17pcs Combination Spanner 6, 7, 8, 9, 10, 11, 12, 13, 14, 15, 16, 17, 18, 19, 20, 21, 22 mm
- 1pc Adjustable Wrench 8"

15件综合维修组套

15 pcs Complete Repair Tool Set

M95080

- 8pcs 呆扳手6x7, 8x9, 10x11, 12x13, 14x15, 16x17, 18x19, 20x22 mm
- 7pcs 活动头套筒扳手8x9,10x11,12x13,14x15,16x17,18x19,20x22 mm
- 8pcs Double Open-end Spanner 6x7, 8x9, 10x11, 12x13, 14x15, 16x17, 18x19, 20x22 mm
- 7pcs Flexible socket wrench 8x9, 10x11, 12x13, 14x15, 16x17, 18x19, 20x22 mm

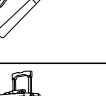
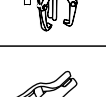
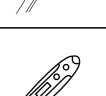
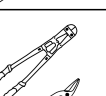
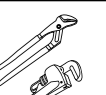
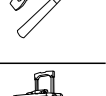
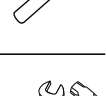
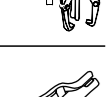
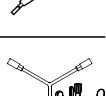
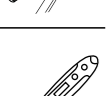
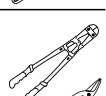
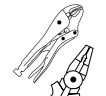

88件综合维修组套

88 pcs Complete Repair Tool Set

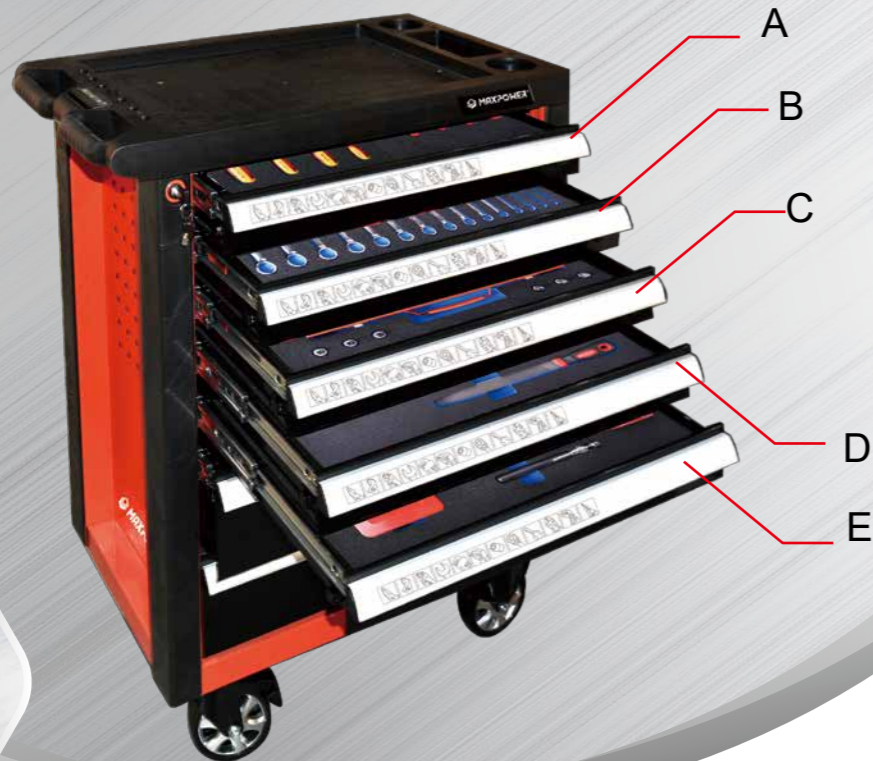

货号
M95057

▶ 适配合工具车M08207



M95058

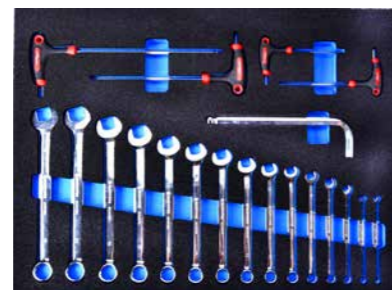

M95059



M95060



M95061

圆柱冲:
2x9.5x150mm
3x9.5x150mm
4x9.5x150mm
5x9.5x150mm
6x12x150mm
8x12x150mm



M95062

17件综合维修组套
17pcs Complete Repair Tool Set

M95058

- 绝缘螺丝批 一字3x100,4x100,5.5x125,6.5x150mm 十字PH0x75,PH1x100,PH2x100
- 双色柄花型螺丝批 T6x75,T7x75,T8x75,T10x75, T15x100, T20x100,T25x100,T27x100,T30x150
- 球头加长内六角扳手 9PCS (1.5,2,2.5,3,4,5,6,8,10)
- 7pcs Insulated Screwdriver Slotted 3x100, 4x100, 5.5x125, 6.5x150mm PH0x75, PH1x100, PH2x100
- 9pcs Bi-color Handle Torx Screwdriver T6x75, T7x75, T8x75, T10x75, T15x100, T20x100, T25x100, T27x100, T30x150
- 9pcs Long Arm Ball Point Hex Key Set (1.5, 2, 2.5, 3, 4, 5, 6, 8, 10)

20件综合维修组套
20pcs Complete Repair Tool Set

M95059

- 加长镜抛两用扳手 6, 7, 8, 9, 10, 11, 12, 13, 14, 15, 16, 17, 18, 19, 20mm
- 双色柄拐杖内六角扳手 2, 3, 4, 6mm
- 球头加长内六角扳手 12mm
- 15pcs Long Combination Wrench 6, 7, 8, 9, 10, 11, 12, 13, 14, 15, 16, 17, 18, 19, 20mm
- 4pcs Bi-color Handle Cane Type Hex Key 2, 3, 4, 6mm
- 1pc Extra Long Arm Ball Point Hex Key 12mm

29件综合维修组套
29pcs Complete Repair Tool Set

M95060

- 铝柄布带式机滤芯扳手
- 1/2"系列套筒28件套组套:
21件公制套筒8,9,10,11,12,13,14,15,16,17,18,19,20, 21,22,23,24,26,27,30,32mm
- 1件棘轮扳手
- 2件火花塞套筒 16,21mm
- 2件接杆125,250mm
- 1件万向接头
- 1件三用头10mm孔x12.5mm方头
- 1pc Strap Wrench
- 28pcs 1/2"Dr.Socket Wrench Set :
21pcs Metric Sockets 8, 9, 10, 11, 12, 13, 14, 15, 16, 17, 18, 19, 20,21, 22, 23, 24, 26, 27, 30, 32mm
- 2pcs Spark Plug Sockets 16, 21mm
- 5pcs Accessories
- 1/2" Driver Quick Release Ratchet Handle
- 1/2" Drive Extension Bars 5", 10"
- Universal Joint 3/8"Fx1/2"M 3-Way Adapter

9件综合维修组套
9pcs Complete Repair Tool Set

M95061

- 7"穴直卡簧钳
- 7"轴直卡簧钳
- 专业6"斜嘴钳
- 专业6"尖嘴钳
- 7"钢丝钳
- 10"圆嘴大力钳
- 8"中齿平锉
- 8"中齿圆锉
- 10"水泵钳
- 1pc Snapping Pliers 7"
- 1pc Snapping Pliers 7"
- 1pc Diagonal Cutting Pliers6"
- 1pc Long Nose Pliers 6"
- 1pc Combination Pliers 7"
- 1pc Curved Jaw Locking Pliers 10"
- 1pc Middle Teeth Flat File 8"
- 1pc Middle Teeth Circle File 8"
- 1pc Box Joint Pliers 10"

12件综合维修组套
12pcs Complete Repair Tool Set

M95062

- 塞尺 0.05-1.0mm
- 金属机油枪 280ml
- 伸缩式反光镜
- 伸缩式捡拾器
- 无弹力防震锤2LB
- 木柄安全钳工锤 0.3kg
- 6pcs 钢样冲组套
- 1pc Feeler Gauge 0.05-1.0mm
- 1pc Pump Oiler
- 1pc Telescopic Mirror
- 1pc Telescopic picker
- 1pc Inelastic Anti-Shock Hammer 2LB
- 1pc Riveting Hammer With Wooden Handle0.3kg
- 6pcs Octagonal Steel Punch Set

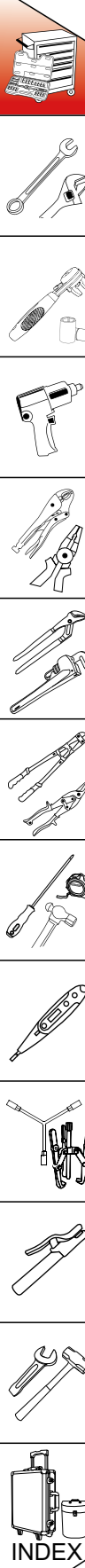

INDEX

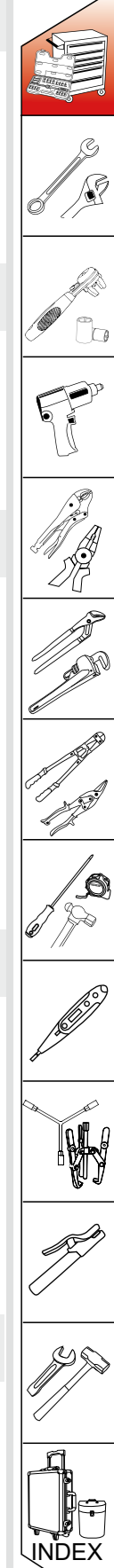

INDEX

80件综合维修组套

80 pcs Complete Repair Tool Set

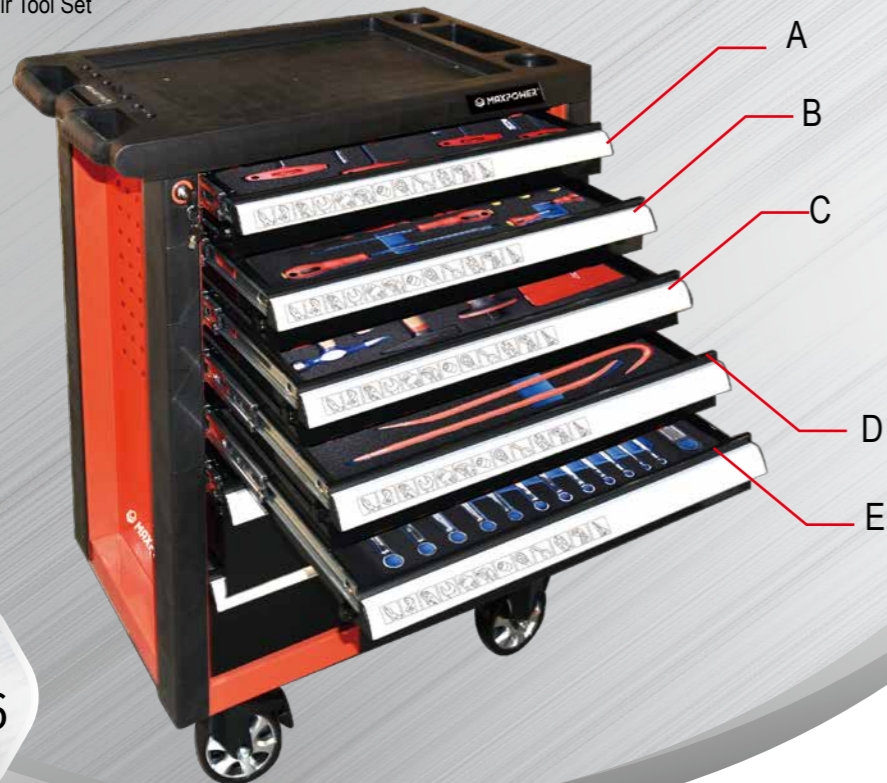

货号
M95066

▶ 适配合工具车M08207

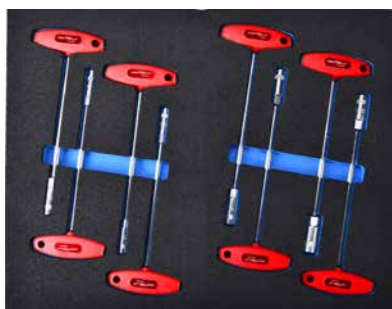

M95067



M95068



M95069



M95070



M95071

8件综合维修组套

8pcs Complete Repair Tool Set

M95067

- 双色柄T型套筒扳手
6,7,8,10,11,12,13,14mm

- 8pcs Bi-color T handle socket wrench
6, 7, 8, 10, 11, 12, 13, 14mm

28件综合维修组套

28pcs Complete Repair Tool Set

M95068

- 绝缘螺丝批: 一字 3x100,4x100,5.5x125,6.5x150mm
十字 PH0x75,PH1x100,PH2x100
- 双色柄螺丝批: 一字6x38,8x200mm
十字PH2x38,PH3x150mm
- 双色柄花型螺丝批: T8x75,T10x75,T15x100,T20x100,
T25x100,T27x100,T30x150 mm
- 球头加长内六角 12mm
- 球头加长内六角组套9PCS (1.5,2,2.5,3,4,5,6,8,10mm)

- 4pcs Insulated Screwdriver Slotted
3x100, 4x100, 5.5x125, 6.5x150mm
- 3pcs Insulated Screwdriver Phillips
PH0x75, PH1x100, PH2x100
- 2pcs Bi-color handle screwdriver Slotted 6x38, 8x200mm
- 2pcs Bi-color handle screwdriver Phillips PH2x38, PH3x150mm
- 7pcs Bi-color handle Torx screwdriver
T8x75, T10x75, T15x100, T20x100, T25x100, T27x100, T30x150 mm
- 1pc Long Arm Ball Point Hex Key 12mm
- 9pcs Long Arm Ball Point Hex Key Set (1.5, 2, 2.5, 3, 4, 5, 6, 8, 10mm)

19件综合维修组套

19pcs Complete Repair Tool Set

M95069

- 八角钢圆锥冲3x9.5x120mm
- 八角钢中心冲4x9.5x120mm
- 八角钢扁凿18x14x175mm
- 八角钢三角冲5x9.5x130mm
- 胶柄扁凿25x19x300mm
- 无弹力防震锤2LB
- 0.3kg木柄安全钳工锤
- 钣金尖嘴锤
- 钣金扁嘴锤
- 钢样冲组套6件套
- 钣金马蹄垫
- 钣金板凳垫
- 钣金缓冲垫
- 钣金小车垫

- 1pc Pin Punch 3x9.5x120mm
- 1pc Center Punch 4x9.5x120mm
- 1pc Octagonal Steel Cold Chisel 18x14x175mm
- 1pc Cape Chisel 5x9.5x130mm
- 1pc Flat Chisel With Plastic Handle 25x19x300mm
- 1pc Inelastic Anti-Shock Hammer 2LB
- 1pc Riveting Hammer With Wooden Handle 0.3kg
- 1pc Pick & Finishing Hammer
- 1pc Straight Finishing Hammer
- 6 pcs Alignment Punch Set
- 1pc Heal Dolly
- 1pc Utility Dolly
- 1pc Double End Dolly
- 1pc Curved Dolly

8件综合维修组套

8pcs Complete Repair Tool Set

M95070

- 水泵钳 250mm
- 航空剪 250mm
- 斜嘴钳 160mm
- 电工剪 145mm
- 7"钢丝钳
- 篱笆钳10"
- 19x400mm撬棍
- 19x400mm弓形撬棍

- 1pc Box Joint Pliers 10"
- 1pc Aviation Snips 10"
- 1pc Diagonal Cutting Pliers 6"
- 1pc Electrician Scissors 5"
- 1pc Combination Pliers 7"
- 1pc Fencing Plier 10"
- 1pc Wrecking Bar 19x400mm
- 1pc Gooseneck Wrecking Bar 19x400mm

16件综合维修组套

16pcs Complete Repair Tool Set

M95071

- 两用扳手6,7,8,9,10,11,12,13,14,15,16,17mm
- 圆嘴大力钳 220mm
- C型大力钳 280mm
- 活扳手 300mm
- 卷尺 5M

- 12pcs Combination Spanner
6, 7, 8, 9, 10, 11, 12, 13, 14, 15, 16, 17mm
- 1pc Curved Jaw Locking Pliers 10"
- 1pc Locking C-clamp 11"
- 1pc Adjustable Wrench 12"
- 1pc Measuring Tape 5M

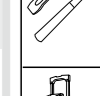
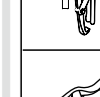
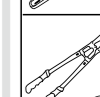
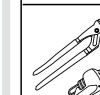
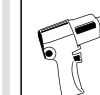
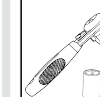
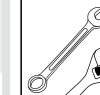

368件通用机修工具车组套

368Pc Automotive Tool Set with Tool Trolley

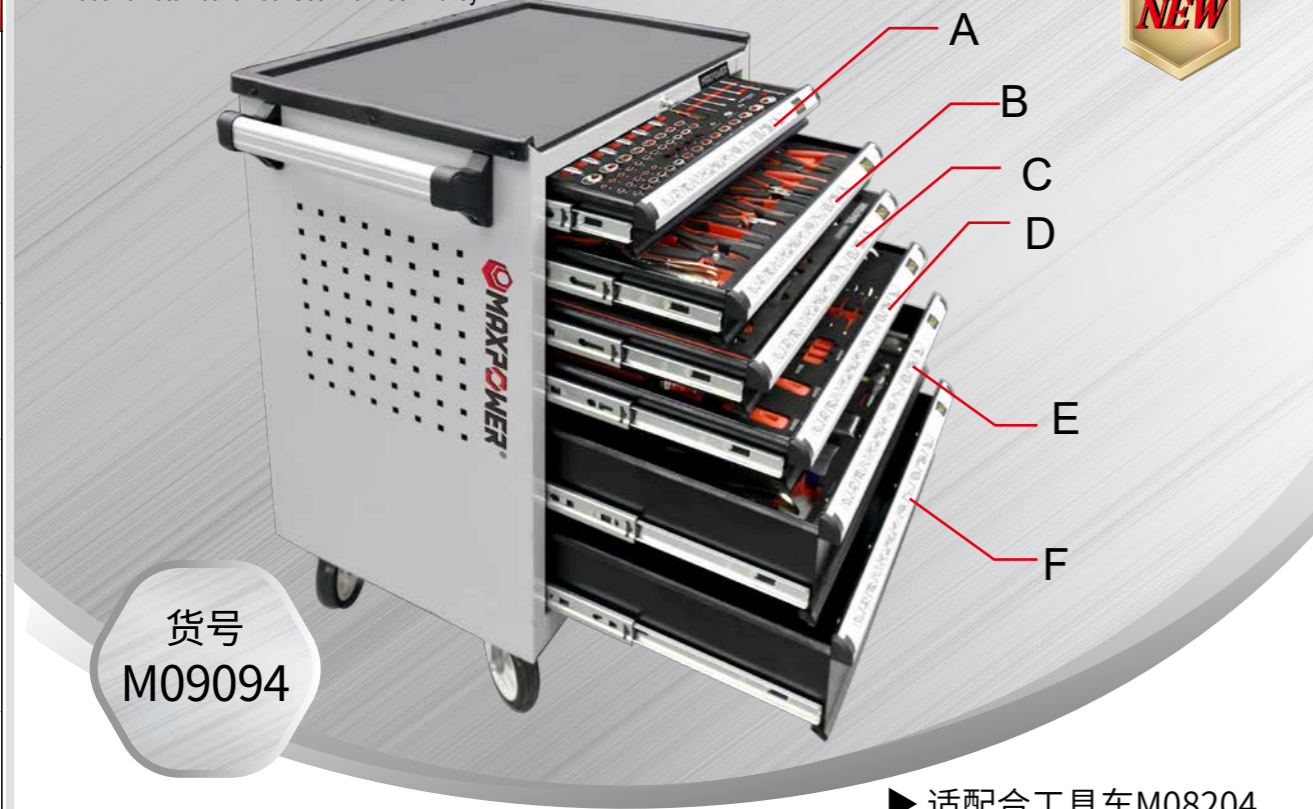

货号
M09094

▶ 适配合工具车M08204



M09094A



M09094B

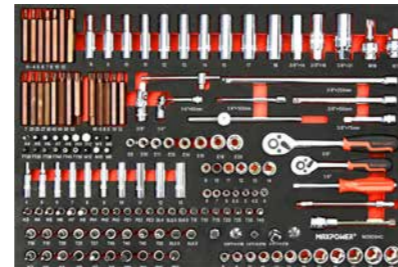

M09094C



M09094D



M09094E

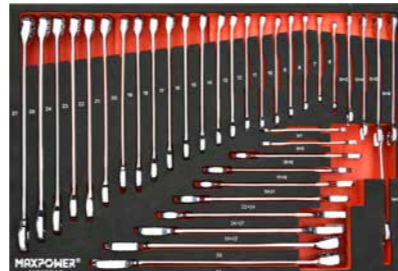

M09094F

M09094A

- 12.5mm系列六角套筒 (20PCS) 8,9,10,11,12,13,14,15,16,17,18,19,20,21,22,23,24,27,30,32mm
- 12.5mm系列六角长套筒 (14PCS) 10,11,12,13,14,15,16,17,18,19,20,21,22,24mm
- 12.5mm系列12角套筒 (20PCS) 8,9,10,11,12,13,14,15,16,17,18,19,20,21,22,23,24,27,30,32mm
- 12.5mm系列12角长套筒 (4PCS) 10,12,13,14mm
- 12.5mm系列专业快速脱落棘轮扳手
- 12.5mm系列滑杆 250mm
- 12.5mm系列转接头 1/2"(F)x3/8"(M)
- 12.5mm系列转向接杆 (2PCS) 5",10"
- 12.5mm系列六角风动套筒 (4PCS) 17,19,21,23mm
- 12.5mm系列L形扳手 250mm
- 12.5mm系列万向接头
- 12.5mm系列三用接头 1/2"(F)x3/8"(M)
- 12.5mm系列旋具头接头 5/16"

M09094B

- 日式轴用直嘴卡簧钳 7"
- 日式轴用弯嘴卡簧钳 7"
- 日式穴用直嘴卡簧钳 7"
- 日式穴用弯嘴卡簧钳 7"
- 尖嘴钳 6"
- 斜嘴钳 6"
- 钢丝钳 8"
- 鲤鱼钳 8"
- 圆口带刃大力钳 10"
- 穿芯柄一字螺丝批 6x150mm
- 穿芯柄十字螺丝批 PH2x150mm
- 一字形螺丝批 (4PCS) 3x75mm,5x100mm,6x100mm,6x38mm
- 十字形螺丝批 (4PCS) PH0x75,PH1x75,PH2x38,PH2x100
- 包胶钢卷尺 5Mx19mm

M09094C

- 8MM系列70MM长六角旋具头 (7PCS) 4,5,6,7,8,10,12mm
- 8MM系列70MM长12角旋具头 (5PCS) M5,M6,M8,M10,M12
- 8MM系列70MM长花形旋具头 (8PCS) T20,T25,T27,T30,T40,T45,T50,T55
- 8MM系列30MM长六角旋具头 (7PCS) 4,5,6,7,8,10,12mm
- 8MM系列30MM长12角旋具头 (5PCS) M5,M6,M8,M10,M12
- 8MM系列30MM长中孔花形旋具头 (6PCS) TT20,TT25,TT30,TT40,TT45,TT50
- 10MM系列旋具头接头 5/16"
- 10MM系列六角套筒 (12PCS) 8,9,10,11,12,13,14,15,16,17,18,19mm
- 10MM系列六角长套筒 (10PCS) 8,9,10,11,12,13,14,15,17,19mm
- 10MM系列六角花形套筒 (8PCS) E8,E10,E11,E12,E14,E16,E18,E20
- 10MM系列中孔花形旋具套筒 (9PCS) T10,T15,T20,T25,T27,T30,T40,T45,T50
- 10MM系列六角旋具套筒 (7PCS) 3,4,5,6,7,8,10
- 10MM系列十字形旋具套筒 (3PCS) PH1,PH2,PH3
- 10MM系列一字形旋具套筒 (2PCS) SL5.5,SL6.5
- 6.3MM系列六角套筒 (13PCS) 4,4.5,5,5.5,6,7,8,9,10,11,12,13,14mm
- 6.3MM系列六角长套筒 (10PCS) 4,5,6,7,8,9,10,11,12,13mm
- 6.3MM系列六角旋具套筒 (6PCS) 3,4,5,6,7,8mm
- 6.3MM系列十字形旋具套筒 (3PCS) PH1,PH2,PH3
- 6.3MM系列米字形旋具套筒 (3PCS) PZ1,PZ2,PZ3
- 6.3MM系列一字形旋具套筒 (3PCS) SL4,SL5.5,SL6.5
- 6.3MM系列花型旋具套筒 (7PCS) T8,T10,T15,T20,T25,T30,T40
- 10MM系列专业快速脱落棘轮扳手
- 10MM系列转向接杆 (3PCS) 3",6",10"
- 10MM系列滑杆
- 10MM系列万向接头
- 10MM系列转接头 (2PCS) 3/8"(F)x1/4"(M),3/8"(F)x1/2"(M)
- 10MM系列火花塞套筒 (2PCS) 16mm,21mm
- 10MM系列12角薄壁火花塞套筒 14mm
- 10MM系列三用接头 3/8"(F)x1/2"(M)
- 6.3MM系列专业快速脱落棘轮扳手
- 6.3MM系列万向接头
- 6.3MM系列接杆 (2PCS) 2",4"
- 6.3MM系列滑杆
- 6.3MM系列旋柄
- 6.3MM系列转接头 1/4"(F)x3/8"(M)
- 6.3MM系列可弯式接头 6"
- M16油底壳放油旋具套筒带孔
- H17油底壳旋具套筒
- T52发动机缸盖螺丝专用旋具套筒

M09094D

- 全抛光双梅花扳手 (11PCS) 10x12,12x14,13x15,13x16,14x17,16x18,17x19,19x21,19x22,22x24,24x27mm
- 穿芯柄一字螺丝批 (2PCS) 8x150,8x200mm
- L型套筒扳手 (12PCS) 6,7,8,9,10,11,12,13,14,15,16,17mm
- 穿芯柄十字螺丝批 (2PCS) PH3x150mm,PH3x200mm
- 活扳手10"

M09094E

- 柔性磁性捡拾器 400mmx1kg
- 撬卡起子
- 内饰件拆卸工具
- 球头雾化内六角扳手组套 (特长) 1.5,2,2.5,3,4,5,6,8,10
- 中孔花形加长扳手组套 T10,15,20,25,27,30,40,45,50
- 钢样冲组套
- 细牙断丝取出器
- 汽车测电笔 6V/12V/24V
- 吹尘枪 100mm
- 塑柄推钮美工刀 13节9x80mm
- 包塑柄圆头锤 1.5LB
- 无弹力防震锤 2.5LB
- 塞尺 0.05-1.00mm
- 三爪式机滤芯扳手 54-116mm

M09094F

- 工业级加长两用扳手 (23PCS) 6,7,8,9,10,11,12,13,14,15,16,17,18,19,20,21,22,23,24,25,27,30,32mm
- 工业级加长双头呆扳手 (13PCS) 6x7,8x10,10x12,12x14,13x15,13x16,14x17,16x18,17x19,18x21,22x24,24x27,30x32mm



249件钣金机修工具车组套

249Pc Automotive Metal Plate Tool Set with Tool Trolley

NEW



货号
M09095

▶ 适配合工具车M08204



M09095A



M09095B



M09095C



M09095D



M09095E

M09095A

- 12.5MM系列六角套筒 (20PCS) 8, 9, 10, 11, 12, 13, 14, 15, 16, 17, 18, 19, 20, 21, 22, 23, 24, 27, 30, 32mm
- 10MM系列六角长套筒 (13PCS) 10, 11, 12, 13, 14, 15, 16, 17, 18, 19, 20, 21, 22mm
- 10MM系列六角套筒 (12PCS) 8, 9, 10, 11, 12, 13, 14, 15, 16, 17, 18, 19mm
- 6.3MM系列六角套筒 (13PCS) 4, 4.5, 5, 5.5, 6, 7, 8, 9, 10, 11, 12, 13, 14mm
- 6.3MM系列专业快速脱落棘轮扳手
- 12.5MM系列专业快速脱落棘轮扳手
- 6.3MM系列转向接杆 (2PCS) 2", 4"
- 12.5MM系列转向接杆 (2PCS) 5", 10"
- 10MM系列万向接头
- 6.3MM系列可弯式接头 6"
- 12.5MM系列转接头 1/2"(F)x3/8"(M)
- 10MM系列12角薄壁火花塞套筒 14mm
- 8MM系列30MM长十字旋具头 (3PCS) PH1, PH2, PH3
- 8MM系列30MM长中孔花形旋具头 (8PCS) TT20, TT25, TT30, TT40, TT45, TT50, TT55, TT60
- 8MM系列30MM长六角旋具头 (5PCS) M5, M6, M8, M10, M12
- 8MM系列70MM长六角旋具头 (8PCS) 4, 5, 6, 7, 8, 10, 12, 14mm
- 8MM系列70MM长花形旋具头 (8PCS) T20, T25, T27, T30, T40, T45, T50, T55
- 12.5MM系列旋具头接头 5/16"
- 10MM系列专业快速脱落棘轮扳手
- 12.5MM系列L形扳手 250mm
- 10MM系列转向接杆 (2PCS) 3", 6"
- 6.3MM系列万向接头
- 12.5MM系列万向接头
- 10MM系列转接头 (2PCS) 3/8"(F)x1/4"(M), 3/8"(F)x1/2"(M)
- 10MM系列火花塞套筒 (2PCS) 16mm, 21mm
- 8MM系列30MM长一字旋具头 (5PCS) SL5.5, SL6.5, SL8, SL10, SL12
- 8MM系列30MM长六角旋具头 (7PCS) 4, 5, 6, 7, 8, 10, 12mm
- 8MM系列70MM长六角旋具头 (7PCS) M5, M6, M8, M10, M12, M14, M16
- 10MM系列旋具头接头 5/16"

M09095B

- 日式轴用直嘴卡簧钳 7"
- 日式轴用弯嘴卡簧钳 7"
- 日式穴用直嘴卡簧钳 7"
- 日式穴用弯嘴卡簧钳 7"
- 尖嘴钳 6"
- 斜嘴钳 6"
- 钢丝钳 8"
- 鲤鱼钳 8"
- 圆口带刃大力钳 10"
- 穿心柄一字螺丝批 6x150mm
- 穿心柄十字螺丝批 PH2x150mm
- 一字形螺丝批 (4PCS) 3x75, 5x100, 6x100, 6x38mm
- 十字形螺丝批 (4PCS) PH0x75, PH1x75, PH2x38, PH2x100
- 包胶钢卷尺 5Mx19mm

M09095C

- 柔性磁性捡拾器 400mmx1kg
- 撬卡起子
- 球头雾化内六角扳手套组 (特长) 1.5, 2, 2.5, 3, 4, 5, 6, 8, 10
- 中孔花形加长扳手套组 T10, 15, 20, 25, 27, 30, 40, 45, 50
- 钢样冲组套
- 细牙断丝取出器
- T52发动机缸盖螺丝专用旋具套筒
- M16油底壳放油旋具套筒带孔
- H17油底壳旋具套筒
- 汽车测电笔 6V/12V/24V
- 吹尘枪 100mm
- 塑柄推钮美工刀 13节9x80mm
- 包塑柄圆头锤 1.5LB
- 无弹力防震锤 2.5LB
- 塞尺 0.05-1.00mm
- 三爪式机滤芯扳手 54-116mm
- 活扳手 10"

M09095D

- 工业级加长两用扳手 (19PCS) 8, 9, 10, 11, 12, 13, 14, 15, 16, 17, 18, 19, 20, 21, 22, 23, 24, 25, 27mm
- 中齿胶柄平锉 8"
- 中齿胶柄半圆锉 8"
- 中齿胶柄圆锉 8"
- 中齿胶柄三角锉 8"
- 金刚石平头扁锉 3x140mm
- 金刚石尖头半圆锉 3x140mm
- 金刚石尖头圆锉 3x140mm

M09095E

- 曲面精整钣金锤 305g
- 直面精整钣金锤 305g
- 鹤嘴精整钣金锤 260g
- 墩型钣金衬铁
- 弯型钣金衬铁
- 扁型钣金衬铁
- 铲型钣金衬铁
- 木柄刮刀
- 焊接大力钳 9"
- 尖嘴带刃大力钳 9"
- 平板金属夹钳 8"
- 内饰件拆卸工具

242件通用机修工具车组套

242Pc Automotive Tool Set with Tool Trolley



货号
M09096

▶ 适配合工具车M08202



M09096A



M09096B



M09096C

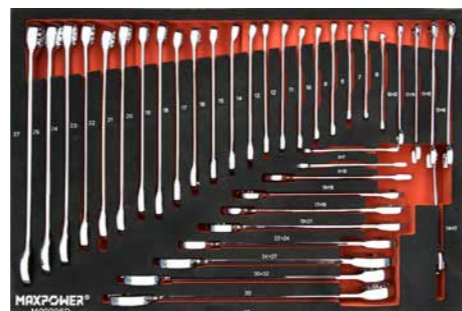

M09096D

M09096A

- 12.5MM系列六角套筒 (20PCS) 8,9,10,11,12,13,14,15, 16, 17, 18, 19, 20, 21, 22, 23, 24, 27, 30, 32mm
- 10MM系列六角长套筒 (13PCS) 10,11,12,13,14,15,16,17,18,19,20,21,22mm
- 10MM系列六角套筒 (12PCS) 8,9,10,11,12,13,14,15,16,17,18,19mm
- 6.3MM系列六角套筒 (13PCS) 4,4.5,5,5.5,6,7,8,9,10,11,12,13,14mm
- 6.3MM系列专业快速脱落棘轮扳手
- 10MM系列专业快速脱落棘轮扳手
- 12.5MM系列专业快速脱落棘轮扳手
- 12.5MM系列L形扳手 250mm
- 6.3MM系列转向接杆 (2PCS) 2",4"
- 10MM系列转向接杆 (2PCS) 3",6"
- 12.5MM系列转向接杆 (2PCS) 5",10"
- 6.3MM系列万向接头
- 12.5MM系列万向接头
- 6.3MM系列可弯式接头 6"
- 10MM系列转接头 (2PCS) 3/8"(F)x1/4"(M),3/8"(F)x1/2"(M)
- 12.5MM系列转接头 1/2"(F)x3/8"(M)
- 10MM系列火花塞套筒 (2PCS) 16,21mm
- 10MM系列12角薄壁火花塞套筒 14mm
- 8MM系列30MM长一字旋具头 (5PCS) SL5.5,SL6.5,SL8,SL10,SL12
- 8MM系列30MM长十字旋具头 (3PCS) PH1,PH2,PH3
- 8MM系列30MM长中孔花形旋具头 (8PCS) TT20,TT25,TT30,TT40,TT45,TT50, TT55,TT60
- 8MM系列30MM长12角旋具头 (5PCS) M5, M6, M8, M10, M12
- 8MM系列30MM长六角旋具头 (7PCS) 4, 5, 6, 7, 8, 10, 12mm
- 8MM系列70MM长六角旋具头 (8PCS) 4, 5, 6, 7, 8, 10, 12, 14mm
- 8MM系列70MM长12角旋具头 (7PCS) M5, M6, M8, M10, M12, M14, M16
- 8MM系列70MM长花形旋具头 (8PCS) T20, T25, T27, T30, T40, T45, T50, T55
- 12.5MM系列旋具头接头 5/16"
- 10MM系列旋具头接头 5/16"

M09096B

- 日式轴用直嘴卡簧钳 7"
- 日式轴用弯嘴卡簧钳 7"
- 日式穴用直嘴卡簧钳 7"
- 日式穴用弯嘴卡簧钳 7"
- 尖嘴钳 6"
- 斜嘴钳 6"
- 钢丝钳 8"
- 鲤鱼钳 8"
- 圆口带刃大力钳 10"
- 穿心柄一字螺丝批 6x150mm
- 穿心柄十字螺丝批 PH2x150mm
- 一字形螺丝批 (4PCS) 3x75, 5x100, 6x100, 6x38mm
- 十字形螺丝批 (4PCS) PH0x75, PH1x75, PH2x38, PH2x100

M09096C

- 柔性磁性捡拾器 400mmx1kg
- 撬卡起子
- 球头雾化内六角扳手套组 (特长) 1.5,2,2.5,3,4,5,6,8,10
- 中孔花形加长扳手套组 T10,15,20,25,27,30,40,45,50
- 钢样冲组套
- 细牙断丝取出器
- T52发动机缸盖螺丝专用旋具套筒
- M16油底壳放油旋具套筒带孔
- H17油底壳旋具套筒
- 汽车测电笔 6V/12V/24V
- 吹尘枪 100mm
- 塑柄推钮美工刀 13节9x80mm
- 包塑柄圆头锤 1.5LB
- 无弹力防震锤 2.5LB
- 塞尺 0.05-1.00mm
- 三爪式机滤芯扳手 54-116mm
- 活扳手 10"

M09096D

- 工业级加长两用扳手 (23PCS) 6, 7, 8, 9, 10, 11, 12, 13, 14, 15, 16, 17, 18, 19, 20, 21, 22, 23, 24, 25, 27, 30, 32mm
- 工业级加长双头呆扳手 (13PCS) 6x7, 8x10, 10x12, 12x14, 13x15, 13x16, 14x17, 16x18, 17x19, 18x21, 22x24, 24x27, 30x32mm

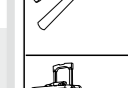
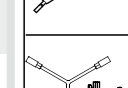
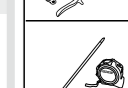
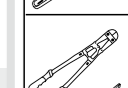
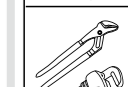
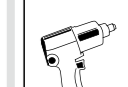
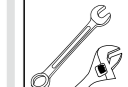

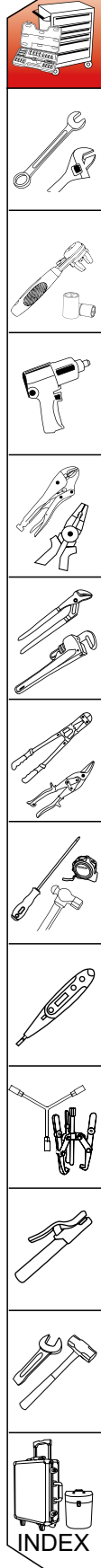
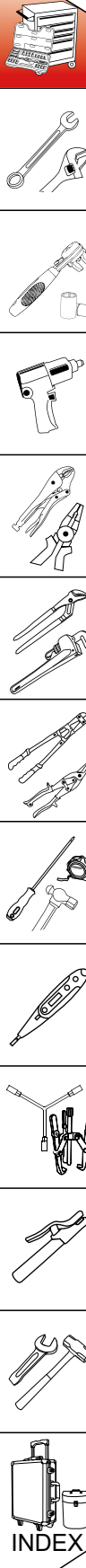

231件机修工具车组套
231Pc Automotive Tool Set with Tool Trolley



货号
M09097

▶ 适配合工具车M08202



M09097A

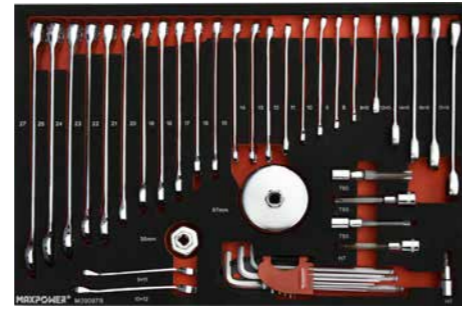

M09097B



M09097C



M09097D

M09097A

- 6.3MM系列六角套筒(13PCS)4,4.5,5,5.5,6,7,8,9,10,11,12,13,14mm
- 6.3MM系列转向(2PCS)2",4"
- 6.3MM系列专业快速脱落棘轮扳手
- 6.3MM系列万向接头
- 6.3MM系列转接头 1/4"(F)x3/8"(M)
- 6.3MM系列花型旋具套筒(7PCS)T8,T10,T15,T20,T25,T30,T40
- 6.3MM系列六角旋具套筒(6PCS)3,4,5,6,7,8mm
- 6.3MM系列十字形旋具套筒(3PCS)PH1,PH2,PH3
- 6.3MM系列一字形旋具套筒(3PCS)SL4,SL5.5,SL6.5
- 6.3MM系列六角长套筒(4PCS)8,9,10,12mm
- 6.3MM系列六角花形套筒(3PCS)E4,E6,E8
- 10MM系列六角套筒(14PCS)6,7,8,9,10,11,12,13,14,15,16,17,18,19mm
- 10MM系列转向接杆(2PCS)3",6"
- 10MM系列六角花形套筒(6PCS)E10,E11,E12,E14,E16,E18
- 10MM系列六角旋具套筒(7PCS)3,4,5,6,7,8,10mm
- 10MM系列花形旋具套筒(9PCS)T15,T20,T25,T27,T30,T40,T45,T50,T55
- 10MM系列专业快速脱落棘轮扳手
- 10MM系列万向接头
- 10MM系列转接头(2PCS)3/8"(F)x1/4"(M),3/8"(F)x1/2"(M)
- 10MM系列火花塞套筒16mm
- 10MM系列12角薄壁火花塞套筒14mm
- 10MM系列六角长套筒(4PCS)13,14,15,17mm
- 12.5MM系列12角套筒(16PCS)10,11,12,13,14,15,16,17,18,19,21,22,24,27,30,32mm
- 12.5MM系列专业快速脱落棘轮扳手
- 12.5MM系列转向接杆(2PCS)5",10"
- 12.5MM系列万向接头
- 12.5MM系列转接头1/2"(F)x3/8"(M)
- 12.5MM系列花形套筒(4PCS)E18,E20,E22,E24
- 12.5MM系列50MM长花形旋具套筒T55
- 1/2"系列六角风动薄壁长套筒(2PCS)17mm,19mm
- 12.5MM系列转向手柄15"

M09097B

- 工业级加长两用扳手(19PCS)8,9,10,11,12,13,14,15,16,17,18,19,20,21,22,23,24,25,27mm
- 全抛光双梅花快扳(5PCS)8x10,12x13,14x15,16x18,17x19mm
- 碗式滤清器扳手(2PCS)36mm,87mm
- 全抛光油管扳手(2PCS)9x11mm,10x12mm
- 12.5MM系列100MM长花形旋具套筒(3PCS)T50, T55, T60
- 12.5MM系列100MM长六角旋具套筒7mm
- 12.5MM系列50MM长六角旋具套筒7mm
- 球头雾化内六角扳手组套(特长)1.5,2,2.5,3,4,5,6,8,10

M09097C

- 花形螺丝批(8PCS)T8x75,T10x100,T15x100,T20x100,T25x100,T27x100,T30x100,T40x100mm
- 一字形螺丝批(4PCS)3x75,5x75,6x150,5x300mm
- 十字形螺丝批(4PCS)PH0x75,PH1x75,PH2x150,PH2x300
- 穿心柄一字螺丝批6x150mm
- 穿心柄十字螺丝批PH2x150mm
- 中孔花形加长扳手组套T10,15,20,25,27,30,40,45,50
- 双色柄多用剪8"
- 钢样冲组套
- 塞尺 0.05-1.00mm
- 柔性磁性捡拾器400mmx1kg
- 撬卡起子
- 美式重型水泵钳10"
- 尖嘴钳 6"

M09097D

- 吹尘枪 250mm
- 钢丝钳 7"
- 斜嘴钳 6"
- 鲤鱼钳 8"
- 圆口带刃大力钳 10"
- 日式轴用直嘴卡簧钳 7"
- 日式穴用直嘴卡簧钳 7"
- 包胶钢卷尺 5mx19mm
- 包塑柄圆头锤 1.5LB
- 无弹力防震锤 2.5LB
- 塑柄推钮美工刀 13节9x80mm
- 内饰件拆卸工具

210件机修工具车组套

210Pc Automotive Tool Set with Tool Trolley



货号
M09098

▶ 适配合工具车M08202

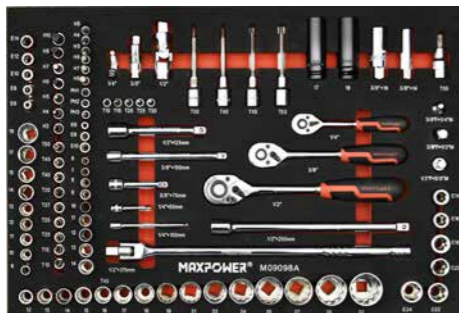

M09098A

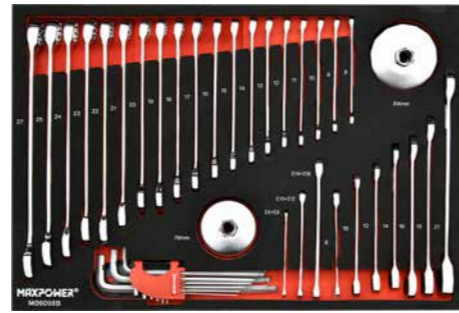

M09098B



M09098C



M09098D

M09098A

- 6.3MM系列六角套筒(9PCS)6,7,8,9,10,11,12,13,14mm
- 6.3MM系列转向接杆(2PCS)2",4"
- 6.3MM系列专业快速脱落棘轮扳手
- 6.3MM系列万向接头
- 6.3MM系列花型旋具套筒(5PCS)T10,T15,T20,T25,T30
- 6.3MM系列六角旋具套筒(6PCS)3,4,5,6,7,8mm
- 6.3MM系列十字形旋具套筒(3PCS)PH1,PH2,PH3
- 6.3MM系列六角花形套筒(3PCS)E6,E8,E10
- 10MM系列六角套筒(9PCS)8,10,11,12,13,14,15,17,19mm
- 10MM系列转向接杆(2PCS)3",6"
- 10MM系列六角花形套筒(5PCS)E6,E8,E10,E12,E14
- 10MM系列六角旋具套筒(7PCS)3,4,5,6,7,8,10mm
- 10MM系列花形旋具套筒(9PCS)T10,T15,T20,T25,T27,T30,T40,T45,T50
- 10MM系列专业快速脱落棘轮扳手
- 10MM系列万向接头
- 10MM系列转接头(2PCS)3/8"(F)x1/4"(M), 3/8"(F)x1/2"(M)
- 10MM系列火花塞套筒16mm
- 10MM系列12角薄壁火花塞套筒14mm
- 12.5MM系列12角套筒(15PCS) 12, 13, 14, 15, 16, 17, 18, 19, 21, 22, 24, 26, 27, 30, 32mm
- 12.5MM系列专业快速脱落棘轮扳手
- 12.5MM系列转向接杆(2PCS)5", 10"
- 12.5MM系列万向接头
- 12.5MM系列转接头1/2"(F)x3/8"(M)
- 12.5MM系列花形套筒(6PCS) E14, E16, E18, E20, E22, E24
- 12.5MM系列50MM长花形旋具套筒 T55
- 1/2"系列六角风动薄壁长套筒(2PCS) 17mm, 19mm
- 12.5MM系列100MM长花形旋具套筒(4PCS) T30, T40, T45, T55
- 12.5MM系列50MM长花形旋具套筒

M09098B

- 工业级加长两用扳手(19PCS)8, 9, 10, 11, 12, 13, 14, 15, 16, 17, 18, 19, 20, 21, 22, 23, 24, 25, 27mm
- 全抛光花形扳手(3PCS) E6xE8, E10xE12, E14xE18
- 工业级棘轮两用扳手(7PCS) 8, 10, 12, 14, 16, 18, 21mm
- 帽式滤清器扳手(2PCS) 76mm,14边, 84mm,14边
- 球头雾化内六角扳手套组(特长) 1.5,2,2.5,3,4,5,6,8,10

M09098C

- 花形螺丝批(8PCS) T8x75,T10x100,T15x100,T20x100,T25x100,T27x100,T30x100,T40x100mm
- 一字形螺丝批(4PCS) 3x75, 5x75, 6x150, 5x300mm
- 十字形螺丝批(4PCS) PH0x75, PH1x75, PH2x150, PH2x300
- 穿心柄一字螺丝批 6x150mm
- 穿心柄十字螺丝批 PH2x150mm
- 中孔花形加长扳手套组 T10,15,20,25,27,30,40,45,50
- 双色柄多用剪8"
- 钢样冲组套
- 塞尺 0.05-1.00mm
- 柔性磁性捡拾器 400mmx1kg
- 撬卡起子
- 美式重型水泵钳 10"
- 尖嘴钳 6"

M09098D

- 吹尘枪 250mm
- 钢丝钳 7"
- 斜嘴钳 6"
- 鲤鱼钳 8"
- 圆口带刃大力钳 10"
- 日式轴用直口卡簧钳 7"
- 日式穴用直口卡簧钳 7"
- 包胶钢卷尺 5mx19mm
- 包塑柄圆头锤 1.5LB
- 无弹力防震锤 2.5LB
- 塑柄推钮美工刀 13节9x80mm
- 内饰件拆卸工具



INDEX



INDEX



178件综合组套

178PCS Complete Tool Set

CR-V



货号 Item No	规格 Size	产品编号 Product No	装箱数 Pc/Box	毛重 GW/CTN
M 07580	6.3/10/12.5mm x 178PCS	TKC13-178	1set	14.00kg

- 23件6.3mm系列套筒4, 4.5, 5, 5.5, 6, 7, 8, 9, 10, 11, 12, 13, 14mm 5/32", 3/16", 7/32", 1/4", 9/32", 5/16", 11/32", 3/8", 7/16", 1/2"
- 14件10mm系列套筒10, 11, 12, 13, 14, 15, 16, 17, 18, 19mm 5/8", 11/16", 3/4", 7/8"
- 18件12.5mm系列套筒20, 22, 23, 24, 25, 26, 27mm 3/8", 7/16", 1/2", 9/16", 5/8", 11/16", 3/4", 13/16", 7/8", 15/16", 1"
- 15件6.3mm系列长套筒6, 7, 8, 9, 10, 11, 12, 13mm 1/4", 9/32", 5/16", 11/32", 3/8", 7/16", 1/2"
- 9件10mm系列长套筒14, 15, 16, 18mm, 9/16", 5/8", 11/16", 3/4", 13/16"
- 4件12.5mm系列长套筒22, 24mm, 7/8", 15/16"
- 2件10mm系列火花塞16, 21mm
- 38件6.3mm系列25mm长旋具头
十字 PH0, 1, 2, 3, 4
一字 SL3, 4, 4.5, 5, 5.5, 6, 7, 8
米字 PZ0, 1, 2, 3, 4
六角 H1.5, 2, 2.5, 3, 4, 5, 6, 8, 10
花型 T8, 10, 15, 20, 25, 27, 30, 40
四方 S1, 2, 3
- 16件内六角扳手1.5, 2, 2.5, 3, 4, 5, 5.5, 6mm 1/16", 5/64", 3/32", 1/8", 5/32", 3/16", 7/32", 1/4"
- 6件螺旋电讯钟表批 十字PH0, 1
一字1.4, 1.8, 2.4, 3.0mm
- 3件6.3mm, 10mm, 12.5mm系列快脱棘轮扳手
- 2件6.3mm系列接杆50, 100mm
- 2件10mm系列接杆75, 150mm
- 2件6.3mm, 10mm系列滑杆
- 1件6.3mm系列旋柄
- 1件6.3mm系列旋具头接头
- 1件6.3mm系列转换接头6.3mm孔x10mm方头
- 1件10mm系列转换接头10mm孔x6.3mm方头
- 1件12.5mm系列转换接头12.5mm孔x10mm方头
- 1件6.3mm系列软接杆
- 1件圆嘴大力钳180mm
- 1件活扳手200mm
- 1件尖嘴钳165mm
- 1件鲤鱼钳150mm
- 1件卷尺7.5m
- 1件羊角锤16盎司
- 2件6.3mm系列批头转换
- 10件两用扳手8, 10, 11, 14, 17mm 5/6", 3/8", 1/2", 5/8", 11/16"

- 23pcs
1/4" Dr.Sockets 4, 4.5, 5, 5.5, 6, 7, 8, 9, 10, 11, 12, 13, 14mm 5/32", 3/16", 7/32", 1/4", 9/32", 5/16", 11/32", 3/8", 7/16", 1/2"
- 14pcs
3/8" Dr.Sockets 10, 11, 12, 13, 14, 15, 16, 17, 18, 19mm 5/8", 11/16", 3/4", 7/8"
- 18pcs
1/2" Dr.Sockets 20, 22, 23, 24, 25, 26, 27mm 3/8", 7/16", 1/2", 9/16", 5/8", 11/16", 3/4", 13/16", 7/8", 15/16", 1"
- 15pcs
1/4" Dr.Deep Sockets 6, 7, 8, 9, 10, 11, 12, 13mm 1/4", 9/32", 5/16", 11/32", 3/8", 7/16", 1/2"
- 9pcs
3/8" Dr.Deep Sockets 14, 15, 16, 18mm, 9/16", 5/8", 11/16", 3/4", 13/16"
- 4pcs
1/2" Dr.Deep Sockets 22, 24mm, 7/8", 15/16"
- 2pcs
3/8" Dr.Spark Plug Sockets 16, 21mm
- 38pcs
1/4" Dr.Shank 25L Bits Philips PH0, PH1, PH2, PH3, PH4 Slotted 3, 4, 4.5, 5, 5.5, 6, 7, 8mm
Pozidriv PZ0, PZ1, PZ2, PZ3, PZ4
Hex 1.5, 2, 2.5, 3, 4, 5, 6, 8, 10mm
Torx T8, T10, T15, T20, T25, T27, T30, T40
Square S1, S2, S3
- 16pcs
Hex keys 1.5, 2, 2.5, 3, 4, 5, 5.5, 6mm 1/16", 5/64", 3/32", 1/8", 5/32", 3/16", 7/32", 1/4"
- 6pcs
Electronic Clock Bits Philips PH0, PH1
Slotted 1.4, 1.8, 2.4, 3.0mm
- 33pcs
Accessories 1/4", 3/8", 1/2" Dr.Quick Release Ratchet Handle
1/4" Dr.Extensions Bars 2", 4"
3/8" Dr.Extensions Bars 3", 6"
1/4", 3/8" Sliding T-bar
1/4" Dr.Spinner Handle
1/4" Dr.Bit Adapter
1/4" Dr.Adapter 1/4" F x 3/8" M
3/8" Dr.Adapter 3/8" F x 1/4" M
1/2" Dr.Adapter 1/2" F x 3/8" M
1/4" Dr.Flexible Extension Bar
Locking Pliers 7"
Adjustable Wrench 8"
Long Nose Pliers 6"
Slip Joint Pliers 6"
7.5m-Metre Tape Measure
16OZ Claw Hammer
Adptor 1/4" Hex x 1/4" S
Adptor 1/4" Hex x 1/4" S
Combination Wrenches 8, 10, 11, 14, 17mm 5/16", 3/8", 1/2", 5/8", 11/16"

△工具空盒及钟表批盒不属于终身保用范围, 盒内所配置的单支产品请参照单支工具的保用条款
△The set box and the watch screwdriver set in plastic case for not included in the coverage of life time warranty, warranty for single item in the set consult the warranty articles for single item.

125件汽保综合组套

125PCS Mechanic's Tool Set for Auto Repairs



货号 Item No	规格 Size	产品编号 Product No	装箱数 Pc/Box	装箱数 Pc/Box	毛重 GW/CTN
M 09014	125PCS	TKC63-125	1set	2sets	20.00kg

- 11件6.3mm系列六角制套筒4, 5, 6, 7, 8, 9, 10, 11, 12, 13, 14mm
- 11件10mm系列六角制套筒9, 10, 11, 12, 13, 14, 15, 16, 17, 18, 19mm
- 7件12.5mm系列六角制套筒20, 21, 22, 24, 27, 30, 32mm
- 8件10mm系列花型六角套筒 E8, E10, E11, E12, E14, E16, E18, E20
- 4件6.3mm系列六角长套筒8, 9, 10, 12mm
- 4件10mm系列六角长套筒13, 14, 15, 17mm
- 2件10mm系列火花塞套筒16, 21mm
- 1件6.3mm系列万向接头
- 1件10mm系列万向接头
- 1件12.5mm系列万向接头
- 1件6.3mm系列接杆50mm
- 2件10mm系列接杆75, 150mm
- 2件12.5mm系列接杆125, 250mm
- 1件6.3mm系列快脱棘轮扳手
- 1件10mm系列快脱棘轮扳手
- 1件12.5mm系列快脱棘轮扳手
- 1件6.3mm系列旋具头接头
- 1件6.3mm系列旋柄
- 9件套球头加长内六角扳手1.5, 2, 2.5, 3, 4, 5, 6, 8, 10mm
- 1件十字耐柄柄穿芯螺丝批PH2x6x100mm
- 1件一字耐柄柄穿芯螺丝批6.0x100mm
- 1件汽车测电笔6V/12V24V及导线
- 1件两用滤清扳手63-102mm
- 1件气缸盖螺丝专用套筒T52
- 12件两用扳手8, 9, 10, 11, 12, 13, 14, 15, 16, 17, 18, 19mm
- 2件10mm系列转换接头
10mm方孔x6.3mm方头, 10mm方孔x12.5mm方头
- 2件10mm系列一字旋具套筒SL5.5, SL6.5mm
- 2件10mm系列十字旋具套筒PH1, PH2
- 4件10mm系列六角旋具套筒H3, H4, H5, H6mm
- 7件10mm系列花型旋具套筒T20, T30, T40, T45, T50, T55, T60
- 2件10mm系列米字套筒PZ1, PZ2
- 4件6.3mm系列25mm长一字旋具头SL3, SL4, SL5, SL6mm
- 4件6.3mm系列25mm长十字旋具头PH0, PH1, PH2, PH3
- 3件6.3mm系列25mm长六角旋具头H4, H5, H6mm
- 4件6.3mm系列25mm长米字旋具头 PZ0, PZ1, PZ2, PZ3
- 4件6.3mm系列25mm长花型旋具头 T15, T20, T25, T30
- 1件6.3mm系列25mm长带珠接杆

- 11pcs 1/4" Dr.6pt Metric Sockets : 4, 5, 6, 7, 8, 9, 10, 11, 12, 13, 14mm
- 11pcs 3/8" Dr.6pt Metric Sockets : 9, 10, 11, 12, 13, 14, 15, 16, 17, 18, 19mm
- 7pcs 1/2" Dr.6pt Metric Sockets : 20, 21, 22, 24, 27, 30, 32mm
- 8pcs 3/8" Dr.Torx Sockets : E8, E10, E11, E12, E14, E16, E18, E20
- 4pcs 1/4" Dr.6pt Deep Metric Sockets : 8, 9, 10, 12mm
- 4pcs 3/8" Dr.6pt Deep Metric Sockets : 13, 14, 15, 17mm
- 19pcs 1/4" Shank 25L Bits PH0, PH1, PH2, PH3
Slotted 3, 4, 5, 6mm
Hex 4, 5, 6mm
T15, T20, T25, T30
PZ0, PZ1, PZ2, PZ3
- 17pcs 3/8" Dr.Bit Sockets
Slotted SL5.5, SL6.5mm
PH1, PH2
PZ1, PZ2
Hex H3, H4, H5, H6mm
T20, T30, T40, T45, T50, T55, T60
- 2pcs Screwdrivers Philips PH2x100mm
Slotted 6x100mm
- 3pcs Quick Release Ratchet Handle 1/4", 3/8", 1/2"
- 3pcs Universal Joint 1/4", 3/8", 1/2"
- 2pcs 3/8" Dr.Spark Plug Sockets 16, 21mm
- 1pc 1/4" Dr. Extension Bars 2"
- 2pcs 3/8" Dr.Extension Bars 3", 6"
- 2pcs 1/2" Dr.Extension Bars 5", 10"
- 1pc 1/4" Dr.Spinner Handle
- 1pc 1/4" Dr.Bit Adapter
- 2pcs Adapter 3/8" Fx1/4" M, 3/8" Fx1/2" M
- 9pcs Long Arm Hex Key Set 1.5, 2, 2.5, 3, 4, 5, 6, 8, 10mm
- 12pcs Combination Wrenches 8, 9, 10, 11, 12, 13, 14, 15, 16, 17, 18, 19mm
- 1pc Automobilt Test Pencile And Conducting Wire
- 1pc Dual-use Filter Wrench
- 1pc Cylinder Cover Dismounting Socket Torx Key
- 1pc Adptor 1/4" Hex x 1/4" S

△工具空盒不属于终身保用范围, 盒内所配置的单支产品请参照单支工具的保用条款
△The set box is not covered by our lifetime warranty. For single product configured in the box, please refer to the single tool warranty terms.



120件套筒组套

120PCS 1/4" & 3/8" & 1/2" Dr. Socket Wrench Set

CR-V



货号 Item No	规格 Size	产品编号 Product No	装箱数 Pc/Carton	毛重 GW/CTN
M 07014	6.3/10/12.5mm x 120PCS	TKC12-120	2sets	20.5kg

- 20件6.3mm系列套筒4, 5, 6, 7, 8, 9, 10, 11, 12, 13mm 5/32", 3/16", 7/32", 1/4", 9/32", 5/16", 11/32", 3/8", 7/16", 1/2"
- 18件10mm系列套筒9, 10, 11, 12, 13, 14, 15, 16, 17, 18, 19mm 3/8", 7/16", 1/2", 9/16", 5/8", 11/16", 3/4"
- 13件12.5mm系列套筒20, 21, 22, 24, 27, 30, 32mm 13/16", 7/8", 15/16", 1", 1-1/16", 1-1/4"
- 4件6.3mm系列制制长套筒8, 9, 10, 11mm
- 4件10mm系列制制长套筒13, 14, 15, 17mm
- 2件10mm系列火花塞16, 21mm
- 8件10mm系列花型套筒E8, 10, 11, 12, 14, 16, 18, 20
- 4件12.5mm系列制制气动套筒17, 19, 21, 24mm
- 7件6.3mm系列中空花型套筒头T10, T15, T20, T25, T27, T30, T40
- 17件10mm系列旋具套筒花型 T20, T30, T40, T45, T50, T55, T60 六角 H3, H4, H5, H6 十字 PH1, PH2 一字 SL5.5, SL6.5 米字 PZ1, PZ2
- 3件6.3mm, 10mm, 12.5mm系列棘轮扳手
- 3件6.3mm, 10mm, 12.5mm系列万向接头
- 1件6.3mm系列接杆50mm
- 2件10mm系列接杆75, 150mm
- 2件12.5mm系列接杆125, 250mm
- 1件6.3mm系列旋柄
- 1件6.3mm系列旋具头接头
- 10件两用扳手8, 9, 10, 11, 12, 13, 14, 17, 18, 19mm
- 20pcs 1/4" Dr. Sockets 4,5,6,7,8,9,10,11,12,13mm 5/32", 3/16", 7/32", 1/4", 9/32", 5/16", 11/32", 3/8", 7/16", 1/2"
- 18 pcs 3/8" Dr. Sockets 9,10,11,12,13,14,15,16,17,18,19mm 3/8", 7/16", 1/2", 9/16", 5/8", 11/16", 3/4"
- 13pcs 1/2" Dr. Sockets 20,21,22,24,27,30,32mm 15/16", 1", 1-1/16", 1-1/4", 13/16", 7/8"
- 4pcs 1/4" Dr. Deep Sockets 8,9,10,11mm
- 4pcs 3/8" Dr. Deep Sockets 13,14,15,17mm
- 2pcs 3/8" Dr. Spark Plug Sockets 16,21mm
- 8pcs 3/8" Dr. Torx Sockets E8,10,11,12,14,16,18,20
- 4pcs 1/2" Dr. Impact sockets 17,19,21,24mm
- 7pcs 1/4" Dr. Torx Bits T-10,15,20,25,27,30,40
- 17pcs 3/8" Dr. Bit Sockets Torx T-20,30,40,45,50,55,60 Hex3,4,5,6mm Philips PH1,PH2 Slotted 5.5,6.5mm Pozidriv PZ1,PZ2
- 23pcs Accessories 1/4", 3/8", 1/2" Dr. Quick Release Ratchet Handle 1/4", 3/8", 1/2" Dr. Universal Joint 1/4" Dr. Extension Bar 2" 3/8" Dr. Extension Bar 3", 6" 1/2" Dr. Extension Bars 5", 10" 1/4" Dr. Spinner Handle 1/4" Dr. Bit Adapter Combination Wrench- 8,9,10,11,12,13,14,17,18,19mm

△ 工具空盒不属于终身保用范围,盒内所配置的单支产品请参照单支工具的保用条款
△ The set box is not covered by our lifetime warranty. For single product configured in the box, please refer to the single tool warranty terms.

94 件公制套筒组套

94PCS 1/4" & 1/2" Dr. Socket Wrench Set

CR-V



货号 Item No	规格 Size	产品编号 Product No	装箱数 Pc/Carton	毛重 GW/CTN
M 09013	6.3/12.5mm x 94PCS	TKC10-94	4sets	26.9kg

- 13件6.3mm系列公制套筒4, 4.5, 5, 5.5, 6, 7, 8, 9, 10, 11, 12, 13, 14mm
- 8件6.3mm系列长套筒6, 7, 8, 9, 10, 11, 12, 13mm
- 18件12.5mm系列公制套筒10, 11, 12, 13, 14, 15, 16, 17, 18, 19, 20, 21, 22, 23, 24, 27, 30, 32mm
- 4件12.5mm系列长套筒14, 15, 17, 19mm
- 2件12.5mm系列火花塞套筒16, 21mm
- 17件6.3mm系列旋具套筒 十字PH1, PH2 一字SL4, SL5.5, SL7 米字PZ1, PZ2 六角H3, H4, H5, H6mm 花型T8, T10, T15, T20, T25, T30
- 15件8mm系列30mm长旋具头 十字PH3, PH4 一字SL8, SL10, SL12 米字PZ3, PZ4 六角H8, H10, H12, H14mm 花型T40, T45, T50, T55 3件内六角扳手1.5, 2, 2.5mm
- 2件6.3mm, 12.5mm系列快脱棘轮扳手
- 1件6.3mm系列T型滑杆手柄
- 2件6.3mm, 12.5mm系列万向接头
- 2件6.3mm系列接杆50, 100mm
- 2件12.5mm系列接杆125, 250mm
- 1件三用接头10mm孔x12.5mm方头
- 1件6.3mm系列软接杆150mm
- 1件6.3mm系列旋柄
- 1件12.5mm系列旋具头接头
- 1件6.3mm系列批头转换
- 13pcs 1/4" Dr. 6pt. Metric Sockets 4,4.5,5,5.5,6,7,8,9,10,11,12,13,14mm
- 8pcs 1/4" Dr. Metric Deep Sockets 6,7,8,9,10,11,12,13mm
- 18pcs 1/2" Dr. 6pt. Metric Sockets 10,11,12,13,14,15,16,17,18,19,20,21,22,23,24,27,30,32mm
- 4pcs 1/2" Dr. Metric Deep Sockets 14,15,17,19mm
- 2pcs 1/2" Dr. Spark Plug Sockets 16,21mm
- 17pcs 1/4" Dr. Bit Sockets Philips PH1,PH2 Slotted 4.5,5,7mm Pozidriv PZ1,PZ2 Hex3,4,5,6mm Torx T8,T10,T15,T20,T25,T30
- 15pcs 8mm Shank 30LBits Philips PH3,PH4 Slotted 8,10,12mm Pozidriv PZ3,PZ4 Torx T40,T45,T50,T55 Hex 8,10,12,14mm
- 3pcs Hex Keys 1.5,2,2.5mm
- 14pcs Accessories 1/4", 1/2" Dr. Quick Release Ratchet Handle 1/4" Dr. Sliding T-bar 1/4", 1/2" Dr. Universal Joint 1/4" Dr. Extension Bars 2", 4" 1/2" Dr. Extension Bars 5", 10" 3/8" F x 1/2" M 3-Way Adapter 1/4" Dr. Flexible Extension Bar 6" 1/4" Dr. Spinner Handle 1/2" Dr. Bit Adapter Adaptor 1/4" Hex x 1/4" S

△ 工具空盒不属于终身保用范围,盒内所配置的单支产品请参照单支工具的保用条款
△ The set box is not covered by our lifetime warranty. For single product configured in the box, please refer to the single tool warranty terms.

90 件公制套筒组套

90PCS 1/4" & 1/2" Dr. Socket Wrench Set

CR-V



货号 Item No	规格 Size	产品编号 Product No	装箱数 Pc/Carton	毛重 GW/CTN
M 07571	6.3/12.5mm x 90PCS	TK-123	1set	14.00kg

- 12件6.3mm系列套筒4, 4.5, 5, 5.5, 6, 7, 8, 9, 10, 11, 12, 13mm
- 13件12.5mm系列套筒14, 15, 16, 17, 18, 19, 20, 21, 22, 24, 27, 30, 32mm
- 2件12.5mm系列火花塞套筒16, 21mm
- 4件螺丝批十字PH1x75mm, PH2x100mm 一字SL5x75mm, SL6x100mm
- 24件6.3mm系列25mm长旋具头 十字PH0, PH1, PH2, PH3 一字SL3, SL4, SL5, SL6 米字PZ0, PZ1, PZ2, PZ3 六角H3, H4, H5, H6 花型T15, T20, T25, T30 四方S0, S1, S2, S3
- 2件6.3mm, 12.5mm系列快脱棘轮扳手
- 2件6.3mm, 12.5mm系列万向接头
- 1件6.3mm系列接杆75mm
- 1件12.5mm系列接杆250mm
- 1件6.3mm系列旋柄65mm
- 1件6.3mm系列磁性旋柄100mm
- 1件钢钳175mm
- 1件尖嘴钳150mm
- 1件斜口钳150mm
- 9件内六角扳手1.5, 2, 2.5, 3, 4, 5, 6, 8, 10mm
- 15件两用扳手6, 7, 8, 10, 11, 12, 13, 14, 15, 16, 17, 18, 19, 21, 22mm
- 12pcs 1/4" Dr. Metric Sockets 4,4.5,5,5.5,6,7,8,9,10,11,12,13mm
- 13pcs 1/2" Dr. Metric Sockets 14,15,16,17,18,19,20,21,22,24,27,30,32mm
- 2pcs 1/2" Dr. Spark Plug Sockets 16,21mm
- 4pcs Screwdrivers Philips PH1x75mm, PH2x100mm
- Slotted 5x75mm, 6x100mm
- 24pcs 1/4" Shank 25L Bits Philips PH0, PH1, PH2, PH3 Slotted SL3, SL4, SL5, SL6 Pozidriv PZD, PZ1, PZ2, PZ3 Hex H3, H4, H5, H6 Torx T15, T20, T25, T30 Square S0, S1, S2, S3
- 35pcs Accessories 1/4", 1/2" Dr. Quick Release Ratchet Handle 1/4", 1/2" Dr. Universal Joint 1/4" Dr. Extension Bars 3" 1/2" Dr. Extension Bars 10" 1/4" Dr. Spinner Handle 1/4" Dr. Magnetic spinner handle Combination Pliers 7" Long Nose Pliers 6" Diagonal Cutting Pliers 6" 9pcs Hex Key Set 1.5, 2.5, 3, 4, 5, 6, 8, 10mm Combination Wrenches 6, 7, 8, 10, 11, 12, 13, 14, 15, 16, 17, 18, 19, 21, 22mm

△ 工具空盒不属于终身保用范围,盒内所配置的单支产品请参照单支工具的保用条款
△ The set box is not covered by our lifetime warranty. For single product configured in the box, please refer to the single tool warranty terms.

60件机修工具组套

60PCS 3/8" Dr. General Maintenance Set

CR-V



货号 Item No	规格 Size	产品编号 Product No	装箱数 Pc/Carton	毛重 GW/CTN
M 07560	10mmx60pcs	TKC12-60	2sets	14.20kg

- 16件10mm系列套筒 6, 7, 8, 9, 10, 11, 12, 13, 14, 15, 16, 17, 18, 19, 20, 21mm
- 1件10mm系列快速脱落棘轮扳手
- 1件10mm系列万向接头
- 9件内六角扳手 1.5, 2, 2.5, 3, 4, 5, 6, 8, 10mm
- 1件活扳手200mm
- 1件双色塑柄钢钳200mm
- 1件双色塑柄尖嘴钳160mm
- 5件卡簧钳
- 1件双色包胶钢卷尺3M
- 1件32片公制塞尺(0.02mm-1mm)
- 1件磁性拾拾器
- 1件钢直尺150mm
- 1件包塑柄圆头锤1LB
- 1件双色柄美工刀100x18mm
- 1件铝合金手电筒
- 7件螺丝批 十字 PH0x75mm, PH1x100mm, PH2x38mm, PH2x150mm 一字 3x75mm, 5x100mm, 6x38mm
- 10件两用扳手8, 10, 11, 12, 13, 14, 15, 16, 18, 19mm
- 1件棘轮两用扳手17mm
- 16pcs 3/8" Dr. Sockets 6,7,8,9,10,11,12,13,14,15,16,17,18,19,20,21mm
- 1pc 3/8" Dr. ratchet Handle
- 1pc 3/8" Universal Joint
- 9pcs Hex Key Wrench 1.5, 2, 2.5, 3, 4, 5, 6, 8, 10mm
- 1pc Adjustable Wrench 200mm
- 1pc Combination Pliers 200mm
- 1pc Long Nose Pliers 160mm
- 5pcs Snap Ring Pliers
- 1pc Measuring Tape 3M
- 1pc Metric Feeler Gange (32pcs 0.02mm-1mm)
- 1pc Magnetic Pick-up Tool
- 1pc Steel Ruler 150mm
- 1pc Ball Peen Hammer 1LB
- 1pc Utility Knife
- 1pc Aluminum Steel Flashlight
- 7pcs Screwdrivers PH0x75mm, PH1x100mm, PH2x38mm, PH2x150mm Slotted 3x75mm, 5x100mm, 6x38mm
- 10pcs Combination Wrench 8, 10, 11, 12, 13, 14, 15, 16, 18, 19mm
- 1pc Ratchet Combination Wrench 17mm

△ 工具空盒不属于终身保用范围,盒内所配置的单支产品请参照单支工具的保用条款
△ The set box is not covered by our lifetime warranty. For single product configured in the box, please refer to the single tool warranty terms.

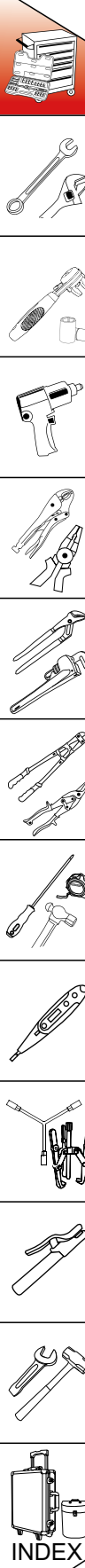

INDEX

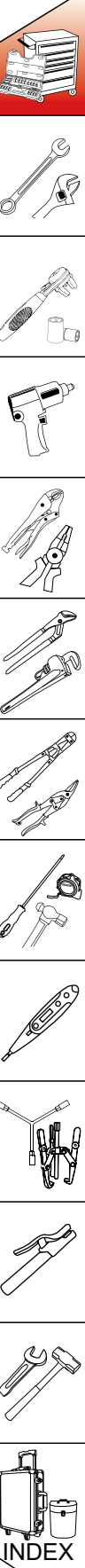

INDEX

60 件套汽修工具组套

60PCS 1/4" & 1/2" Dr. Socket Set For Automobile

CR-V



货号 Item No	规格 Size	产品编号 Product No	装箱数 Pc/ Carton	毛重 GW/CTN
M 09516	60pcs	TKC10-60	4sets	25.50kg

- 12件全抛光两用扳手 8, 9, 10, 11, 12, 13, 14, 15, 16, 17, 18, 19mm
- 13件6.3mm系列六角套筒 4, 4.5, 5, 5.5, 6, 7, 8, 9, 10, 11, 12, 13, 14mm
- 2件6.3mm系列接杆 50, 100mm
- 1件6.3mm系列万向接头
- 1件6.3mm系列T型滑杆手柄
- 1件6.3mm系列旋柄
- 1件6.3mm系列软接杆 150mm
- 1件6.3mm系列快速脱落棘轮扳手
- 18件12.5mm系列六角套筒 10, 11, 12, 13, 14, 15, 16, 17, 18, 19, 20, 21, 22, 23, 24, 27, 30, 32mm
- 1件12.5mm系列快速脱落棘轮扳手
- 2件12.5mm系列接杆 125, 250mm
- 1件12.5mm系列万向接头
- 1件12.5mm系列三用接头
- 2件12.5mm系列火花塞套筒 16, 21mm
- 3件内六角扳手 1.5, 2, 2.5mm
- 12pcs Mirror Finish Combination Wrenches 8,9,10,11,12,13,14, 15,16,17,18,19mm
- 13pcs 1/4" DR.6P Socktes 4,4.5,5,5.5,6,7,8,9,10,11,12,13,14mm
- 2pcs 1/4" DR.Extension Bar 50mm,100mm
- 1pc 1/4" DR.Universal Joint
- 1pc 1/4" DR.Sliding T Bar
- 1pc 1/4" DR.Spinner Handle
- 1pc 1/4" DR.Flexible Extension Bar 150mm
- 1pc 1/4" DR.Ratchet Handle With Quick Release
- 18pcs 1/2" DR.6P Socktes 10,11,12,13,14,15,16,17,18, 19,20,21,22,23,24,27,30,32
- 1pc 1/2" DR.Ratchet Handle With Quick Release
- 2pcs 1/2" DR.Extension Bar 5" ,10"
- 1pc 1/2" DR.Universal Joint
- 1pc 1/2" DR.3-Way Adapter
- 2pcs 1/2" DR.Spark Plug Socker 16,21mm
- 3pcs Hex Key 1.5,2,2.5mm

△ 工具空盒不属于终身保用范围,盒内所配置的单支产品请参照单支工具的保用条款
△ The set box is not covered by our lifetime warranty. For single product configured in the box, please refer to the single tool warranty terms.

38 件 10mm 系列公制套筒扳手组套

38PCS 3/8" Dr. Socket Tool Set

CR-V



货号 Item No	规格 Size	产品编号 Product No	装箱数 Pc/ Carton	毛重 GW/CTN
M 07140	10mm x 38pcs	TKT2-38	12sets	23.00kg

- 15件10mm系列公制套筒 6, 7, 8, 9, 10, 11, 12, 13, 14, 15, 16, 17, 18, 19, 22mm
- 3件内六角扳手 1.5, 2, 2.5mm
- 15件6.3mm系列25mm长旋具头
十字 PH0, PH1, PH2
一字 SL3, SL4, SL5
四方 S1, S2, S3
六角 H3, H4, H5
花型 T10, T15, T20
- 1件10mm系列棘轮扳手
- 1件6.3mm系列旋具头接头
- 1件6.3mm系列旋柄
- 1件尖嘴钳 125mm
- 1件活扳手 150mm
- 15pcs 3/8" Dr. 6pt. Metric Sockets 6,7,8,9,10,11,12,13,14,15,16,17,18,19,22mm
- 3pcs Hex Kcys 1.5,2,2.5mm
- 5pcs 1/4" shank 25L Bits Philips PH0,PH1, PH2 Slotted SL3,SL4,SL5mm
Hex H3,H4,H5mm
Torx T10,T15,T20
Square S1,S2,S3
- 5pcs Accessories
3/8" Dr. Stubby Ratchet Handle, Quick Release
1/4" Dr. Spinner Handle
1/4" Dr. Bit adapter
Long Nose Pliers 5"
Stubby Adjustable Wrench 6"

△ 工具空盒不属于终身保用范围,盒内所配置的单支产品请参照单支工具的保用条款
△ The set box is not covered by our lifetime warranty. For single product configured in the box, please refer to the single tool warranty terms.

33 件 6.3mm 系列公制套筒组套

33PCS 1/4" Dr. Socket Wrench Set

CR-V



货号 Item No	规格 Size	产品编号 Product No	装箱数 Pc/ Carton	毛重 GW/CTN
M 07002	6.3mm x 33pcs	TKC26-33	12sets	16.20kg

- 12件6.3mm系列公制套筒 4, 4.5, 5, 5.5, 6, 7, 8, 9, 10, 11, 12, 13mm
- 3件内六角扳手 1.5, 2, 2.5mm
- 12件6.3mm系列旋具套筒
十字 PH1, PH2 一字 SL3, SL4, SL5, SL6, SL7 六角 H3, H4, H5, H6, H8
- 1件6.3mm系列快脱棘轮扳手
- 1件6.3mm系列T型滑杆手柄
- 2件6.3mm系列接杆 50, 100mm
- 1件6.3mm系列万向接头
- 1件6.3mm系列旋柄
- 12pcs 6pt. Metric Sockets 4, 4.5, 5, 5.5, 6, 7, 8, 9, 10, 11, 12, 13mm
- 3pcs Hex Keys 1.5, 2, 2.5mm
- 12pcs Bit Sockets Slotted 3, 4, 5, 6, 7mm
Phillips PH1, PH2 Hex H3, H4, H5, H6, H8mm
- 6pcs Accessories Quick Release Ratchet Handle
Sliding T-bar Universal Joint
Extension Bars 2", 4" Spinner Handle

△ 工具空盒不属于终身保用范围,盒内所配置的单支产品请参照单支工具的保用条款
△ The set box is not covered by our lifetime warranty. For single product configured in the box, please refer to the single tool warranty terms.

32 件 12.5mm 系列公制套筒组套

32PCS 1/2" Dr. Socket Wrench Set

CR-V



货号 Item No	规格 Size	产品编号 Product No	装箱数 Pc/ Carton	毛重 GW/CTN
M 07026	12.5mm x 32pcs	TKC19-32	4sets	24.00kg

- 22件12.5mm系列公制六角套筒 8, 9, 10, 11, 12, 13, 14, 15, 16, 17, 18, 19, 20, 21, 22, 23, 24, 26, 27, 28, 30, 32mm
- 1件12.5mm系列公制六角套筒 19mm
- 1件12.5mm系列旋齿头 52mm
- 1件12.5mm系列棘轮扳手
- 1件12.5mm系列转向手柄 250mm
- 1件12.5mm系列快速摇柄
- 1件12.5mm系列T型滑杆手柄
- 1件12.5mm系列万向接头
- 2件12.5mm系列接杆 125, 250mm
- 1件12.5mm系列通用手柄 250mm
- 23pcs Metric Sockets 8, 9, 10, 11, 12, 13, 14, 15, 16, 17, 18, 19, 19, 20, 21, 22, 23, 24, 26, 27, 28, 30, 32mm
- 1pc Screwdriver 52mm
- 8pcs Accessories Ratchet Handle
Flex Handle 10" Speed Handle
Sliding T-bar Universal Joint
Extension Bars 5", 10"
Tommy bar 10"

△ 工具空盒不属于终身保用范围,盒内所配置的单支产品请参照单支工具的保用条款
△ The set box is not covered by our lifetime warranty. For single product configured in the box, please refer to the single tool warranty terms.

32 件 (D 型) 12.5mm 系列公制套筒组套

32PCS 1/2" Dr. Socket Wrench Set



货号 Item No	规格 Size	产品编号 Product No	装箱数 Pc/ Carton	毛重 GW/CTN
M 07023	12.5mm x 32pcs	TKT7-32D	4sets	25.50kg

- 22件12.5mm系列公制六角套筒 8, 9, 10, 11, 12, 13, 14, 15, 16, 17, 18, 19, 20, 21, 22, 23, 24, 26, 27, 28, 30, 32mm
- 4件12.5mm系列公制六角套筒 11, 12, 14, 17 mm
- 1件12.5mm系列棘轮扳手
- 2件12.5mm系列接杆 125, 250mm
- 1件L型扳手
- 1件三用头 10mm 孔 x 12.5mm 方头
- 1件快速摇柄
- 22pcs 6pt. Metric Sockets 8, 9, 10, 11, 12, 13, 14, 15, 16, 17, 18, 19, 20, 21, 22, 23, 24, 26, 27, 28, 30, 32mm
- 4pcs 12pt. Metric Sockets 11, 12, 14, 17 mm
- 6pcs Accessories Quick Release Ratchet Handle
Extension Bars 5", 10"
L-handle
3/8" Fx 1/2" M 3-Way Adapter
Tommy Bar 10"

△ 工具空盒不属于终身保用范围,盒内所配置的单支产品请参照单支工具的保用条款
△ The set box is not covered by our lifetime warranty. For single product configured in the box, please refer to the single tool warranty terms.

32 件 (E 型) 12.5mm 系列公制套筒组套

32PCS 1/2" Dr. Socket Wrench Set



货号 Item No	规格 Size	产品编号 Product No	装箱数 Pc/ Carton	毛重 GW/CTN
M 07024	12.5mm x 32pcs	TKC27-32E	4sets	18.30kg

- 19件12.5mm系列公制六角套筒 8, 9, 10, 11, 12, 13, 14, 15, 16, 17, 18, 19, 20, 21, 22, 24, 27, 30, 32mm
- 6件12.5mm系列公制六角套筒 10, 12, 13, 14, 17, 19mm
- 2件12.5mm系列火花塞套筒 16, 21mm
- 1件12.5mm系列棘轮扳手
- 2件12.5mm系列接杆 125, 250mm
- 1件三用接头 10mm 孔 x 12.5mm 方头
- 1件12.5mm系列万向接头
- 19pcs 6pt Metric Sockets 8, 9, 10, 11, 12, 13, 14, 15, 16, 17, 18, 19, 20, 21, 22, 24, 27, 30, 32mm
- 6pcs 12pt Metric Sockets 10, 12, 13, 14, 17, 19mm
- 2pcs Spark Plug Sockets 16, 21mm
- 5pcs Accessories Quick Release Ratchet Handle
Extension Bars 5", 10"
3/8" F x 1/2" M 3-Way Adapter
Universal Joint

△ 工具空盒不属于终身保用范围,盒内所配置的单支产品请参照单支工具的保用条款
△ The set box is not covered by our lifetime warranty. For single product configured in the box, please refer to the single tool warranty terms.

28 件 12.5mm 系列公制套筒组套
28PCS 1/2" Dr. Socket Wrench Set

CR-V



货号 Item No	规格 Size	产品编号 Product No	装箱数 Pc/Carton	毛重 GW/CTN
M 07011	12.5mm x 28PCS	TKT5-28	4sets	18.60kg

- 21件12.5mm系列公制套筒8,9,10,11,12,13,14,15,16,17,18,19, 20,21,22,23,24,26,27,30,32mm
- 1件12.5mm系列棘轮扳手
- 2件12.5mm系列火花塞套筒 16,21mm
- 2件12.5mm系列接杆125,250mm
- 1件12.5mm系列万向接头
- 1件三用头10mm孔x12.5mm方头
- 21pcs Metric Sockets 8,9,10,11,12,13,14,15,16,17,18,19, 20,21,22,23,24,26,27,30,32mm
- 2pcs Spark Plug Sockets 16,21mm
- 5pcs Accessories Quick Release Ratchet Handle Extension Bars 5", 10" Universal Joint 3/8" Fx1/2" M 3-Way Adapter

△ 工具空盒不属于终身保用范围, 盒内所配置的单支产品请参照单支工具的保用条款
△ The set box is not covered by our lifetime warranty. For single product configured in the box, please refer to the single tool warranty terms.

21 件 12.5mm 系列公制套筒组套
21PCS 1/2" Dr. Socket Wrench Set



货号 Item No	规格 Size	产品编号 Product No	装箱数 Pc/Carton	毛重 GW/CTN
M 07006	12.5mm x 21PCS	TKT4-21	4sets	13.00kg

- 18件12.5mm系列公制套筒 8,9,10,11,12,13,14,15,16,17,18, 19,21,22,24,27,30,32mm
- 1件12.5mm系列接杆 125mm
- 1件L型弯柄
- 1件12.5mm快脱棘轮扳手
- 18pcs Metric Sockets 8,9,10,11,12,13,14,15,16,17,18, 19,21,22,24,27,30,32mm
- 1/2" Drive Extension Bar 5"
- L-handle
- 1/2" Drive Quick Release Ratchet

△ 工具空盒不属于终身保用范围, 盒内所配置的单支产品请参照单支工具的保用条款
△ The set box is not covered by our lifetime warranty. For single product configured in the box, please refer to the single tool warranty terms.

24 件 12.5mm 系列公制套筒组套
24PCS 1/2" Dr. Socket Wrench Set

NEW



货号 Item No	规格 Size	产品编号 Product No	装箱数 Pc/Carton	毛重 GW/CTN
M 07012	12.5mm x 24PCS	TKT18-24	4sets	23.00kg

- 18件12.5mm系列公制套筒: 10,11, 12,13,14,15,16,17,18, 19, 20,21, 22, 23,24, 27,30, 32mm
- 2件12.5mm系列接杆 125,250mm
- 1件12.5mm滑行手柄
- 1件12.5mm系列转向手柄375mm
- 1件12.5mm系列万向节头
- 1件12.5mm系列棘轮扳手
- 18 pcs metric sockets: 10,11, 12,13,14,15,16,17,18, 19, 20, 21, 22, 23,24, 27,30, 32mm
- 2 pcs 1/2" extension bars 125,250mm
- 1 pc 1/2" sliding T bar
- 1 pc 1/2" 375mm flex handle
- 1 pc universal joint
- 1 pc ratchet

△ 工具空盒不属于终身保用范围, 盒内所配置的单支产品请参照单支工具的保用条款
△ The set box is not covered by our lifetime warranty. For single product configured in the box, please refer to the single tool warranty terms.

21件套20mm系列公制套筒组套
21PCS 3/4" Dr. Socket Wrench Set



货号 Item No	规格 Size	产品编号 Product No	装箱数 Pc/Carton	毛重 GW/CTN
M 07421	20mm x 21PCS	TKT8-21	1set	14.10kg

- 15件20mm系列公制套筒
19,21,22,24,27,30,32,33,34,35,36,38,41,46,50mm
- 2件20mm系列450mm滑行杆及滑行头
- 1件20mm系列200mm接杆
- 1件20mm系列400mm接杆
- 1件20mm系列475mm棘轮扳手
- 1件20mm系列475mm转向手柄
- 15pcs 3/4"DR. sockets
19,21,22,24,27,30,32,33,34,35,36,38,41,46,50mm
- 2pcs 3/4"DR. 450mm sliding
- T-bar (with sliding head)
- 1pc 3/4"DR. 200mm extension bar
- 1pc 3/4"DR. 400mm extension bar
- 1pc 3/4"DR. 475mm ratchet wrench
- 1pc 3/4"DR. 475mm flexible handle

△ 工具空盒不属于终身保用范围, 盒内所配置的单支产品请参照单支工具的保用条款
△ The set box is not covered by our lifetime warranty. For single product configured in the box, please refer to the single tool warranty terms.

26件套20mm+25mm系列公制套筒
26PCS 3/4" & 1" Dr. Socket Wrench Set

CR-V



货号 Item No	规格 Size	产品编号 Product No	装箱数 Pc/Carton	毛重 GW/CTN
M 07406	19/25mm x 26PCS	TKC12-26	1set	17.80kg

- 17件20mm系列公制套筒
21,22,23,24,26,27,28,29,30,31,32,34,36,38,41,46,50mm
- 3件25mm系列公制套筒 55,60,65mm
- 1件20mm系列快脱棘轮扳手
- 1件20mm系列接杆 200mm
- 1件20mm系列万向节
- 1件20mm系列两用型滑行杆手柄
- 1件三用接头20mm孔x25mm方头
- 1件加力杆
- 17pcs 3/4"Dr. 12pt Sockets
21,22,23,24,26,28,29,30,31,32,34,36,38,41,46,50mm
- 3pcs 1"Dr. 12pt Sockets 55,60,65mm (2-1/4", 2-3/8", 2-5/8")
- 3/4" Dr. Ratchet
- 3/4" Dr. Extension Bar 8"
- 3/4" Dr. Universal Joint
- 3/4" Dr. Dual Function Sliding T Bar
- 3/4" F x 1" M 3-Way Adapter
- Force Adding Bar

△ 工具空盒不属于终身保用范围, 盒内所配置的单支产品请参照单支工具的保用条款
△ The set box is not covered by our lifetime warranty. For single product configured in the box, please refer to the single tool warranty terms.

10 件 12.5mm 系列公制套筒组套
10PCS 1/2" Dr. Socket Wrench Set

CR-V



货号 Item No	规格 Size	产品编号 Product No	装箱数 Pc/Carton	毛重 GW/CTN
M 07050	12.5mm x 10PCS	TKT3-10	12sets	21.50kg

- 8件12.5mm系列公制套筒 8,10,12,14,17,19,21,24mm
- 1件L型弯柄
- 1件三用接头10mm孔x12.5mm方头
- 8pcs 6pt. Metric Sockets 8,10,12,14,17,18,19,21,24mm
- 2pcs Accessories L-Handle 3/8" F x 1/2" M 3-Way Adapter

△ 工具空盒不属于终身保用范围, 盒内所配置的单支产品请参照单支工具的保用条款
△ The set box is not covered by our lifetime warranty. For single product configured in the box, please refer to the single tool warranty terms.



21 件 12.5mm 系列公制套筒塑盒组套
21PCS. 1/2" Dr. Socket Wrench Set



★本品即将下架, 售完为止

货号 Item No	规格 Size	产品编号 Product No	装箱数 Pcs/Carton	毛重 GW/CTN
M 07004	12.5mm x 21pcs	TKC1-21	4sets	14.50kg

- 12件短套筒
10, 11, 12, 13, 14, 15, 16, 17, 18, 19, 22, 24mm
- 3件长套筒 13, 17, 19mm
- 1件棘轮扳手
- 2件火花塞套筒
16, 21mm
- 1件接杆 250mm
- 1件万向接头
- 1件三用头
10mm孔x12.5mm 方头
- 12pcs Metric Sockets
10, 11, 12, 13, 14, 15, 16, 17, 18, 19, 22, 24mm
- 3pcs Deep Socket
13, 17, 19mm
- 2pcs Spark Plug Sockets
16, 21mm
- 4pcs Accessories Quick Release Ratchet Handle
Universal Joint
Extension Bars 10
3/8"Fx1/2" M 3-Way Adapter

△ 工具空盒不属于终身保用范围, 盒内所配置的单支产品请参照单支工具的保用条款
△ The set box is not covered by our lifetime warranty. For single product configured in the box, please refer to the single tool warranty terms.

INDEX

77件机修工具组套
77PCS. 1/4"&1/2"Dr. General Maintenance Set

CR-V



★本品即将下架, 售完为止

货号 Item No	规格 Size	产品编号 Product No	装箱数 Pcs/Carton	毛重 GW/CTN
M 07084	6.3/12.5mmx77pcs	TKC23-77	4pcs	29.80kg

- 10件6.3mm系列套筒4,5,6,7,8,9,10,11,12,13mm
- 13件12.5mm系列套筒
10,11,12,13,14,15,16,17,18,19,22,24,27mm
- 2件12.5mm系列火花塞16mm,21mm
- 2件6.3mm,12.5mm系列快速脱落棘轮扳手
- 2件6.3mm,12.5mm系列万向接头
- 2件12.5mm系列接杆125mm,250mm
- 1件三用接头10mm孔X12.5mm方头
- 1件6.3mm系列接杆100mm
- 1件6.3mm系列旋柄
- 1件6.3mm系列旋柄头接头
- 1件木柄安全钳工锤0.3kg
- 1件工业级大力钳180mm
- 1件6.3mm系列T型滑杆手柄
- 1件双色塑柄钢丝钳160mm
- 1件磁性捡拾器
- 4件螺丝批 十字 PH1x75mm PH2x100mm
一字 6x100mm 8x150mm
- 25件6.3mm系列25mm长旋具头
⊕ 十字 PH0,PH1,PH2,PH3,PH4
⊖ 一字 SL3,SL4,SL5,SL6,SL7mm
○ 六角 H2,H3,H4,H5,H6mm
⊛ 花型 T10,T15,T20,T25,T30
⊙ 米字 PZ0,PZ1,PZ2,PZ3,PZ4
- 9件两用扳手8,10,12,13,14,15,17,19,22mm

△ 工具空盒不属于终身保用范围, 盒内所配置的单支产品请参照单支工具的保用条款
△ The set box is not covered by our lifetime warranty. For single product configured in the box, please refer to the single tool warranty terms.

- 10pcs 1/4" Dr. Sockets 4,5,6,7,8,9,10,11,12,13mm
- 13pcs 1/2" Dr. Sockets 10,11,12,13,14,15,16,17,18,19,22,24,27mm
- 2pcs 1/2"Dr.Spark Plug Sockets 16&21mm
- 2pcs Ratchet Handles 1/4"&1/2"Dr.
- 2pcs Universal Joint 1/4"&1/2"Dr.
- 2pcs 1/2"Dr.Extension Bar 125&250mm
- 1pc 3-way Adapter 3/8"(F)X1/2"(M)
- 1pc 1/4"Dr.Extension Bar 100mm
- 1pc 1/4"Dr. Spinner Handle
- 1pc 1/4"Dr. Bit Adaptor
- 1pc Mechanist Hammer 0.3kg
- 1pc Curvedjaw Locking Plier 180mm
- 1pc 1/4"Dr Sliding T-bar
- 1pc Combination Pliers 160mm
- 1pc Magnetic Pick-up Tool
- 4pcs Screwdrivers PH1x75mm PH2x100mm
Slotted 6.5x100mm 8x150mm
- 25pcs 1/4"Dr.25mm Bits PH0,PH1,PH2,PH3,PH4
Slotted SL3,SL4,SL5,SL6,SL7mm Hex H2,H3,H4,H5,H6mm
Torx T10,T15,T20,T25,T30 Pozi PZ0,PZ1,PZ2,PZ3,PZ4
- 9pcs Combination Wrench 8,10,12,13,14,15,17,19,22mm

△ 工具空盒不属于终身保用范围, 盒内所配置的单支产品请参照单支工具的保用条款
△ The set box is not covered by our lifetime warranty. For single product configured in the box, please refer to the single tool warranty terms.



棘轮扳手、工具和套筒

- ▶ 棘轮扳手适用于快速的拧紧和拆卸
- ▶ 避免急速移动棘轮扳手, 这样会造成冲击
- ▶ 四方驱动和接杆、套筒的方驱尺寸必须相同
- ▶ 确保钢珠牢靠地卡在钢珠槽内
- ▶ 总是采用拉工具手柄的方式而不能用推的方式
- ▶ 使用冲击式扳手, 只能选用相应的套筒和连接杆。使用安全销钉和安全环确保套筒, 延长杆和扳手连接安全
- ▶ 当使用由大变小的变径接头时, 需要使用更小的扭矩
- ▶ 不要将棘轮扳手当撬棒或敲击工具使用



智能工具车是专门针对工具行业的移动管理场景下,可满足各类工具实现自动化管理的高性能、易操作、智能设备。

- ▶ 可选配刷卡、人脸、指纹等多种方式登录;
- ▶ 全封闭柜体设计,有效屏蔽外部干扰信息源;
- ▶ 每层抽屉独立锁控,由软件自由组合开锁顺序;
- ▶ 一键盘点,识别准确率达99.99%;
- ▶ 取出和归还实时更新,存取记录通过WIFI或4G自动更新系统后台;
- ▶ 工具未及时归还时,工具车将会发出警告,快速锁定相关人员责任;
- ▶ 现场作业后发现工具遗失的,可通过RFID手持机查找遗失工具;
- ▶ 抽屉:配置不同深度的抽屉,可以满足不同的存储需求;
- ▶ 滑轨:抽屉两侧采用叠加式滚珠滑轨,承载能力更强;
- ▶ 独立锁控系统:抽屉配合独立电子锁,可选择性打开抽屉,防止因同时打开多个抽屉致使车身重心偏移而倾倒;
- ▶ 应用场景:航空、铁路、电力、船舶、监狱等行业



RFID智能工具箱
RFID Detection Tool Box

货号
M08195



尺寸	370mmx245mmx470mm (宽x深x高)
重量	8kg
材质	西南铝+高强度塑料
待机时间	2小时
显示屏	5寸触摸屏
刷卡器	包含
10000mAh电池	包含(可定制扩增)
电量显示	包含
USB接口	包含
开机按钮	包含
充电按钮	包含

INDEX

RFID智能移动四抽工具车

RFID Detection 4-Drawer Rolling Tool Cabinet



货号
M08209



- ▶ 通过计算机结合RFID系统,采用人脸识别或员工牌绑定工具及使用者。
- ▶ 对工具、使用者等完成智能化管理,实时查看所有信息的在库状态、出库状态、领用信息状态,产品提醒状态,产品寿命管理状态。
- ▶ 杜绝拿错、账物不符等状况。

尺寸	778mmx615mmx1038mm (宽x深x高)
重量	120kg
抽屉	4层
每层最大承重	50kg
整机功率	150W
电池容量	无
操作系统	Windows7
屏尺寸	14寸
分辨率	1280x768
CPU处理器	J1900
内存/硬盘	4G/64G



INDEX

RFID智能移动七抽工具车

RFID Detection 7-Drawer Rolling Tool Cabinet

货号
M08197

NEW

工作台采用独特的注塑成型工艺，把手采用双软胶注塑加工而成，更加符合人机工程。

采用125mm大直径PU轮，受力面积增大，能轻松地越过小型障碍物，轮芯采用滚珠轴承，保证使用寿命，高承载能力和顺畅度

使用10.1寸工业触摸屏，屏幕可折叠，自带阻尼，0-110°角度可调，适用不同高度维修人员

工具车四周配有新型复合材料制成的防护条，能有效防止在使用过程中工具车发生碰撞后的安全性

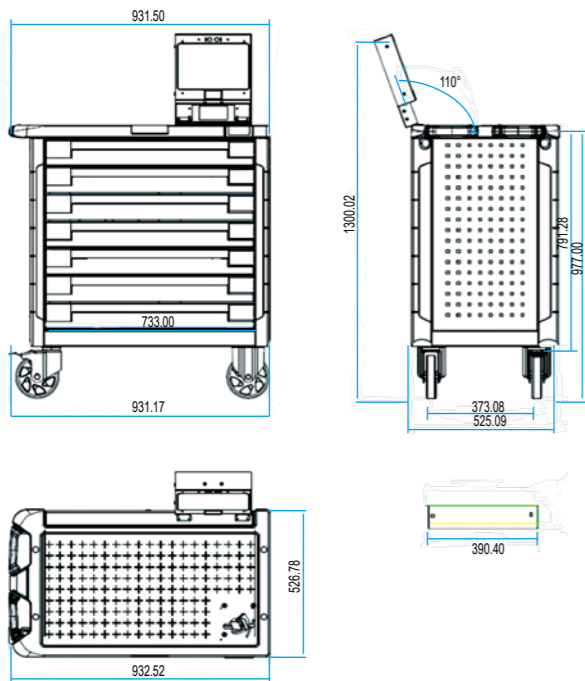

尺寸	930mmx525mmx980mm(宽x深x高)
重量	200kg
抽屉	7层
每层最大承重	80kg
整机屏蔽	≤5cm
整机功耗	约45W
电池容量	40安时
供电电源	5A, 220V
操作系统	支持Android/Windows
盘点时间	≤5秒
CPU处理器	RK3288四核
主频	1.8GHz
显示接口	HDMI
屏尺寸	10.1寸
分辨率	1920x1200
以太网	10/100自适应
WIFI	支持
4G	可选配

RFID智能移动八抽工具车

RFID Detection 8-Drawer Rolling Tool Cabinet

NEW

货号
M08198

控制面板
Control panel



警示灯
Warning Light

多层抽屉设计
Multi-drawer design

双轮刹车
Two wheel brakes

采用重型叠加式滚珠滑道
Heavy-duty twist-and-roll ball slides
加长伸展距离
for longer reach and
使抽屉能100%拉开
100% drawer opening

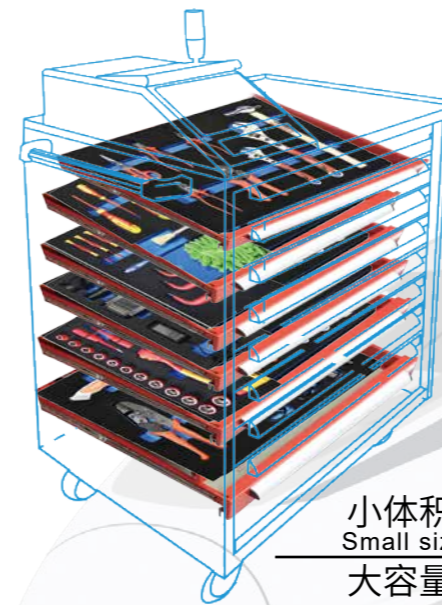

尺寸	980mmx600mmx1330mm(宽x深x高)
重量	约160kg
抽屉	8层
每层最大承重	40kg
单层抽屉尺寸	690mmx510mm(宽x深)
上层抽屉间隔高度	1-7层内空:50mm
下层抽屉间隔高度	第8层内空:150mm
电流、电压	5A / 24V
功率	50W
工控主机	RK3288/4核主频1.8Ghz
光电	原装进口1组
可编程控制器	国产
电路控制系统	配合国产PLC
显示	10.1寸电容屏 1280x800(16:9)
屏蔽距离	20~30cm

8抽屉柜型工具车

8 Tray Tool Chests

NEW

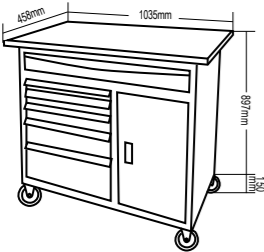

抽屉尺寸: 第一层904x410x105mm 第二层: 545x410x50.5mm 第三、四层545x410x78mm
第五层545x410x160mm 第六层 545x410x242mm 柜中两抽屉尺寸: 299x408x78mm

货号 Item No	规格 Size	装箱数 Pc/Carton	单支重 NW/PC
M08206	1035x458x897mm	1pc	104.00kg

- 箱体、抽屉、隔板1.2MM冷轧钢板
- 工具车中控锁, 配两把钥匙
- 8抽屉设计, 45mm宽重型钢珠轨道
- 抽屉把手为亚光R型铝饰条加塑料胶塞
- 脚轮PP材质, 其中两个活动轮带侧刹
- 30mm厚MDF工作台面, 噪音低, 方便工具使用
- 单抽屉承重35KG, 最下层大抽屉承重45KG, 整体额定承载240KG.
- 1.2mm cold-rolled steel plate for cabinet body, drawer and partition door.
- Equipped with a central control lock and two keys.
- 8-drawer design, 45mm wide heavy steel ball track.
- Drawer handles are matt R-shaped aluminum trim strips and plastic rubber plugs.
- The casters are made of PP, two of the movable wheels have side brakes.
- 30mm thick MDF work surface, low noise, easy to use with tools.
- The single drawer bears 35KG, the bottom large drawer bears 45KG, and the overall rated load is 240KG.

5抽屉维修工具车

5 Tray Tool Chests



抽屉尺寸: 570x400x72mm (顶层小抽屉), 570x400x150mm (下方4抽屉)

货号 Item No	规格 Size	装箱数 Pc/Carton	单支重 NW/PC
M08203	800x470x820mm	1pc	54.00kg

- 1锁多用, 车轮双刹车
- 箱体冷轧板的厚度不得小于0.8mm-1.0mm
- 扶手采用铝合金模具压铸成型
- 采用重型叠加式滚珠滑道, 加长伸展距离使抽屉能100%拉开
- 大小抽屉承载不低于50kg; 车轮静载重350kg
- Multi-purpose lock, double wheel brakes
- The thickness of the cold rolled plate of the box is more than 0.8mm-1.0mm
- The handrail is die-casted with an aluminum alloy mold
- Heavy duty stacked ball slides, extended stretch distance allows drawers to be pulled 100% out
- The drawer carries more than 50kg, the static load of the wheel is 350kg.

维修工具车

7 Tray Tool Chests

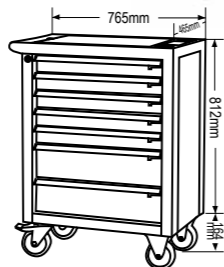

抽屉尺寸: 530x400x65mm

货号 Item No	规格 Size	装箱数 Pc/Carton	毛重 GW/CTN	单支重 NW/PC
M 08207	765x465x812mm	1pc	62.00kg	60.000kg

- 采用优质冷轧板及角铁加工而成, 配有优质钢珠滑道, 耐压、刚性强, 载重大
- 本品属于易耗品, 不属于终身保用范围
- Made of superior cold-rolled Fine paint surface, nick resistance
- No warranty as consumables



工作台面

三层单抽屉工具车

Tri Level Tool Vehicle



货号 Item No	规格 Size	装箱数 Pc/Carton	毛重 GW/CTN	单支重 NW/PC
M 08124	27"(685x465x685mm)	1pc	31.5kg	29.9kg

- 采用优质冷轧板及角铁加工而成, 耐压、刚性强, 载重大
- 钢制抽屉把手, 脚踏滑道, 单抽屉设计
- 本品属于易耗品, 不属于终身保用范围
- Made of superior cold-rolled Fine paint surface, nick resistance
- No warranty as consumables

三层工具车

Tri Level Tool Vehicle



货号 Item No	规格 Size	装箱数 Pc/Carton	毛重 GW/CTN	单支重 NW/PC
M 08125	719x365x663mm	1pc	13.3kg	12.00kg

- 采用优质冷轧板及角铁加工而成, 耐压、刚性强, 载重大 表面喷漆, 防止划伤
- 本品属于易耗品, 不属于终身保用范围
- Made of superior cold-rolled Fine paint surface, nick resistance
- This product is a consumable item, excluded from Maxpower's lifetime warranty.

手提式工具箱 (ABS)

Portable Tool Box (ABS)



最大载重量: 25kg

货号 Item No	规格 Size	装箱数 Pc/Carton	单支重 NW/PC
M08251	18"(500x420x200mm)	2pcs	5.00kg

- 改性加固ABS, 增强铝框, 坚固耐用
- 双层铰链, 加厚支撑杆
- 改性加固ABS, 增强铝框, 坚固耐用
- Double locking, shock resistant
- Multiple configurations of inner cores are convenient for fixing tool identification.

拉杆式工具箱 (ABS)

Trolley Tool Box (ABS)



最大载重量: 30kg

货号 Item No	规格 Size	装箱数 Pc/Carton	单支重 NW/PC
M08257	19"(515x445x260mm)	2pcs	6.8kg

- 改性加固ABS, 增强铝框, 坚固耐用
- 多重配置内芯, 方便工具标识固定
- 加强拉杆, 伸缩自如, 带有2个脚轮
- Double locking, shock resistant
- Double-layer hinge, thickened support rod
- Reinforced telescopic handle, with 2 casters.

拉杆式安全箱

Trolley Safety Box



最大载重量: 35kg

货号 Item No	规格 Size	装箱数 Pc/Carton	单支重 NW/PC
M08269	21"(609x428x263mm)	1pc	10.6kg

- 防尘、防水IP67, 坚固耐用
- 自动气阀, 耐冲击锁扣
- Dustproof, waterproof IP67, sturdy and durable.
- Suitable for temperature -30°C to 80°C.
- Automatic air valve, shock resistant lock.
- Reinforced telescopic handle, with 2 casters.

手提式安全箱 (PP)

Portable Safety Box (PP)



最大载重量: 25kg

货号 Item No	规格 Size	装箱数 Pc/Carton	单支重 NW/PC
M08263	17"(468x365x185mm)	2pcs	5.30kg

- 防尘、防水IP67, 坚固耐用
- 环境温度-30°C到80°C
- 自动气阀, 耐冲击锁扣
- 耐低温-40°C
- Dustproof, waterproof IP67, sturdy and durable.
- Suitable for temperature -30°C to 80°C.
- Automatic air valve, shock resistant lock.
- Low temperature resistance -40°C

翻斗式手提工具箱

Tipping Type Tool Box



货号 Item No	规格 Size	装箱数 Pc/Carton	毛重 GW/CTN	单支重 NW/PC
M 08176	17*(420×200×224mm)	1pc	4.60kg	4.00kg

- 采用优质冷轧板加工而成，耐压、刚性强
- 表面喷塑，防止擦伤
- 重负荷金属挂钩
- △ 本品属于易耗品，不属于终身保用范围
- Made of superior cold-rolled
- Fine paint surface, nick resistance
- △ No warranty as consumables

加强型塑料工具箱

Tool Box



货号 Item No	规格 Size	装箱数 Pc/Carton	毛重 GW/CTN	单支重 NW/PC
M 08161	360 × 160 × 180mm	12pcs	12.60kg	0.917kg
M 08162	400 × 200 × 200mm	9pcs	12.00kg	1.222kg
M 08163	450 × 230 × 200mm	6pcs	10.50kg	1.583kg

- 采用优质 PP 料及冷轧板加工而成，耐压、抗冲击力强
- △ 本品属于易耗品，不属于终身保用范围
- Made of PP material and cold-rolled plates, durable
- △ No warranty as consumables

巡检包

Tool Bag



货号 Item No	规格 Size	装箱数 Pc/Carton	毛重 GW/CTN	单支重 NW/PC
M 08189	230× 70 × 245mm	20pcs	11.8kg	0.56kg

- 高级420D防水牛津布，经久耐用
- △ 本品属于易耗品，不属于终身保用范围
- Made of high quality 420D water proof Oxford fabric.
- △ No warranty as consumables

双兜防水背包

Double-pocket Waterproof Backpack



铁工具箱

Tool Box



货号 Item No	规格 Size	装箱数 Pc/Carton	毛重 GW/CTN	单支重 NW/PC
M 08173	17*(430 × 180 × 190mm)	1pc	3.50kg	3.000kg

- 采用优质冷轧板加工而成，耐压、刚性强
- 表面喷塑，防止擦伤
- 重负荷金属挂钩
- △ 本品属于易耗品，不属于终身保用范围
- Made of superior cold-rolled · Fine paint surface, nick resistance
- △ No warranty as consumables

塑铁工具箱

Tool Box



货号 Item No	规格 Size	装箱数 Pc/Carton	毛重 GW/CTN	单支重 NW/PC
M 08167	360 × 185 × 180mm	8pcs	15.80kg	1.875kg
M 08168	400 × 200 × 190mm	6pcs	14.40kg	2.167kg
M 08169	450 × 240 × 200mm	6pcs	18.00kg	2.833kg

- 采用优质 PP 料加工而成，耐压、抗冲击力强
- △ 本品属于易耗品，不属于终身保用范围
- Made of PP material, durable
- △ No warranty as consumables

单兜防水背包

Single-pocket Waterproof Backpack



货号 Item No	规格 Size	装箱数 Pc/Carton	毛重 GW/CTN	单支重 NW/PC
M 08181	350 × 100 × 300mm	40pcs	22.5kg	0.52kg

- 高级600x600D防水牛津布，耐磨、防水
- △ 本品属于易耗品，不属于终身保用范围
- Made of high quality 600x600D water proof Oxford fabric.
- △ No warranty as consumables

货号 Item No	规格 Size	装箱数 Pc/Carton	毛重 GW/CTN	单支重 NW/PC
M 08182	300 × 150 × 230mm	40pcs	21.4kg	0.50kg

- 高级600x600D防水牛津布，耐磨、防水
- △ 本品属于易耗品，不属于终身保用范围
- Made of high quality 600x600D water proof Oxford fabric.
- △ No warranty as consumables

电工腰包

Electrician's Tool Pouch



货号 Item No	规格 Size	装箱数 Pc/Carton	毛重 GW/CTN	单支重 NW/PC
M 08215	7 袋	40pcs	8.98kg	0.208kg

- 高级600x600D防水牛津布，耐磨、防水
- △ 本品属于易耗品，不属于终身保用范围
- Made of high quality 600x600D water proof Oxford fabric.
- △ No warranty as consumables

手提防水工具包

Tool Bag



货号 Item No	规格 Size	装箱数 Pc/Carton	毛重 GW/CTN	单支重 NW/PC
M 08185	340 × 180 × 280mm	24pcs	19.00kg	0.74kg

- 高级600x600D防水牛津布，耐磨、防水，冷拔钢丝提高工具包强度
- △ 本品属于易耗品，不属于终身保用范围
- Made of high quality 600x600D water proof Oxford fabric, durable and waterproof
- △ No warranty as consumables

6 袋式组合工具腰包

6 Pockets Combined Tool Pockets



货号 Item No	规格 Size	装箱数 Pc/Carton	毛重 GW/CTN	单支重 NW/PC
M 08212	6 袋	40pcs	16.80kg	0.38kg

- 高级1680D防水牛津布，加厚镶边，有效防磨损。
- 支撑式主袋口 + 多重工具插袋，便于工作环境下的工具取用和携行
- 高密度垫层，防止工具穿刺
- △ 本品属于易耗品，不属于终身保用范围
- Made of high quality 1680D water proof Oxford fabric. The extra thick · embroidering can resist abrasion.
- Supporting main pocket + several tool pockets, easy to carry and fetch the tools
- High density cushion, avoid of piercing of tools
- △ No warranty as consumables

7 袋式组合工具腰包

7 Pockets Combined Tool Pockets



8 袋式组合工具腰包

8 Pockets Combined Tool Pockets



货号 Item No	规格 Size	装箱数 Pc/Carton	毛重 GW/CTN	单支重 NW/PC
M 08214	8 袋	40pcs	23.00kg	0.54kg

- 高级1680D防水牛津布，加厚镶边，有效防磨损。
- 支撑式主袋口 + 多重工具插袋，便于工作环境下的工具取用和携行
- 高密度垫层，防止工具穿刺
- △ 本品属于易耗品，不属于终身保用范围
- Made of high quality 1680D water proof Oxford fabric. The extra thick · embroidering can resist abrasion.
- Supporting main pocket + several tool pockets, easy to carry and fetch the tools
- High density cushion, avoid of piercing of tools
- △ No warranty as consumables

工作腰带

Working Belt



货号 Item No	规格 Size	装箱数 Pc/Carton	毛重 GW/CTN	单支重 NW/PC
M 08218	110cm	40pcs	6.20kg	0.140kg

- 选用高级 700D 防水 PVC 牛津布料，加厚镶边，有效防磨损。
- 高密度垫层，耐磨损 · 需配工具腰包使用
- △ 本品属于易耗品，不属于终身保用范围
- Made of high quality 900D water proof PVC Oxford fabric.
- The extra thick embroidering can resist abrasion.
- High density cushion can resist abrasion
- △ No warranty as consumables

夜巡包-铁路专用

Night Watch Bag - Railway Special



货号 Item No	规格 Size	装箱数 Pc/Carton	毛重 GW/CTN	单支重 NW/PC
M 08193	470x110x330mm	10pcs	11.00kg	1.02kg

- 高级900x900D防水牛津布，耐磨、防水，冷拔钢丝提高工具包强度
- 带有反光条，反光系数高，夜间安全警示尤为明显，保护人身安全
- △ 本品属于易耗品，不属于终身保用范围
- Made of high quality 900x900D water proof Oxford fabric.
- △ No warranty as consumables

货号 Item No	规格 Size	装箱数 Pc/Carton	毛重 GW/CTN	单支重 NW/PC
M 08213	7 袋	40pcs	7.20kg	0.27kg

- 高级600x600D防水牛津布，加厚镶边，有效防磨损。
- 支撑式主袋口 + 多重工具插袋，便于工作环境下的工具取用和携行
- 高密度垫层，防止工具穿刺
- △ 本品属于易耗品，不属于终身保用范围
- Made of high quality 600x600D water proof Oxford fabric. The extra thick · embroidering can resist abrasion.
- Supporting main pocket + several tool pockets, easy to carry and fetch the tools
- High density cushion, avoid of piercing of tools
- △ No warranty as consumables

扳手类工具

Wrench

- 扭力扳手及插件 37-39
- 活扳手 40-42
- L扳手 43
- 两用/梅花/呆扳手及组套 43-48
- 敲击扳手 48
- 内六角扳手及套装 49-53
- 双头尖尾棘轮扳手 54
- Torque Wrench 37-39
- Wrench 40-42
- L Wrench 43
- Wrench & Wrench Set 43-48
- Slugging Wrench 48
- Hex key & Hex key Set 51-53
- Double Tail Ratchet Wrench 54



预置式扭力扳手 Preset Torque Wrench



货号 Item No.	驱动头 Square Drive	扭力范围 (N.m)	总长 (L)	装盒数 Pc/Box	单支重 NW/PC
★ M18150	1/4"	5-25	225mm	1pc	0.76kg
M18151	3/8"	10-60	423mm	1pc	1.08kg
M18152	1/2"	20-110	482mm	1pc	1.10kg
M18153	1/2"	28-210	503mm	1pc	1.56kg
M18154	1/2"	65-340	570mm	1pc	1.96kg
M18155	3/4"	160-800	1055mm	1pc	5.90kg
M18159	1"	300-1500	1260mm	1pc	9.20kg

- 采用优质钢材制造, 表面抛光处理
- 双层镀铬, 防锈能力强, 扭矩精度高 $\pm 3\%$
- 进口产品, 使用寿命长, 精准度高
- ★头部为圆形
- △本品属于易耗品, 不属于终身保用范围
- Made of high-quality steel, mirror finish
- Chrome plated with good anti-rust ability, High precision $\pm 3\%$
- Imported product with longer life time, no need to calibrate
- △No warranty as consumables

数显扭力扳手 Digital display torque wrench



货号 Item No.	驱动头 Square Drive	扭力范围 (N.m)	总长 (L)	装盒数 Pc/Box	单支重 NW/PC
M18324	3/8"	10-135	394	1 pc	1.05kg a.
M18327	1/2"	20-200	569	1 pc	1.35kg a.
M18328	1/2"	34-340	769	1 pc	1.70kg a.
M18331	3/4"	80-800	1248	1 pc	5.94kg b.
M18333	1"	150-1500	1248	1 pc	6.00kg b.

- 水滴型双向棘轮头, 方便正反双向切换
- 柄部合金管材质, 整体热处理, 不易变形
- 精度等级 $\pm 1.5\%$, $\pm 2\%$
- 带有LED显示屏, 警示灯和蜂鸣器, 手柄具有震动提醒功能, 防止扭力超载
- 双色TPR手柄, 符合工程力学设计
- Bi-directional ratchet head for convenient forward and reverse bidirectional switching
- Handle made of alloy tube material, overall heat treatment, not easily deformed
- Accuracy level $\pm 1.5\%$, $\pm 2\%$
- With LED display, warning light and buzzer, the handle has a vibration alert function to prevent torque overload
- Bi-color TPR handle, in line with engineering mechanics design

视窗型预置式扭力扳手 Preset Torque Wrench



货号 Item No.	驱动头 Square Drive	扭力范围 (N.m)	总长 (L)	装盒数 Pc/Box	单支重 NW/PC
M 18182	3/8"	12-60	328mm	1pc	0.70kg
M 18184	1/2"	40-200	459mm	1pc	1.00kg
M 18185	1/2"	60-340	679mm	1pc	1.55kg

- 棘轮头上下切换, 允许对顺时针/逆时针双向进行扭矩控制
- 精确度达到读值的 $\pm 3\%$, 满足ISO6789-1:2017
- 啮合角 6° 以内, 适应于狭小空间, 方便快捷
- 用于工具储存的便捷挂钩, 有助于扭矩扳手的解锁和调整
- 视窗型设计, 读数方便快捷
- △本品属于易耗品, 不属于终身保用范围
- The ratchet head switches up and down, allowing for two-way torque control in both clockwise/counterclockwise directions.
- Accuracy is $\pm 3\%$ of the reading and meets ISO6789-1:2017.
- The meshing angle is within 6° , which is convenient for quick and small space.
- A convenient hook for tool storage that helps unlock and adjust the torque wrench.
- Window-style design, convenient and fast reading.
- △No warranty as consumables

智能数显扭力扳手 Smart Torque Wrench



货号 Item No.	驱动头 Square Drive	扭力范围 (N.m)	装盒数 Pc/Box	单支重 NW/PC
M18410	1/2"	17-85	1pc	0.85kg
M18411	1/2"	40-200	1pc	1.10kg
M18412	1/2"	60-335	1pc	1.40kg

- 精确度 $\pm 1\%$, 具有1000组记忆
- 个性化软件开发等功能
- WIFI开关: 与电脑进行数据传输
- 零点校准: 完全松力状态下, 数值不为零时进行校准
- 模式选择: 峰值模式与跟踪模式
- 单位选择: 可选单位有N-m, ft-lb, in-lb, kg-cm
- △本品属于易耗品, 不属于终身保用范围
- Accuracy $\pm 1\%$, with 1000 sets of memory
- Customized software development and other functions
- WIFI switch: data transmission with computer
- Zero calibration: Calibration is performed when the digital display value is not zero in the fully released state
- Mode selection: peak mode and tracking mode
- Unit selection: Available units are N-m, ft-lb, in-lb, kg-cm
- △No warranty as consumables

应用领域

高端工业领域

轨道交通领域

智能技术
显示功能

文字数字
菜单功能

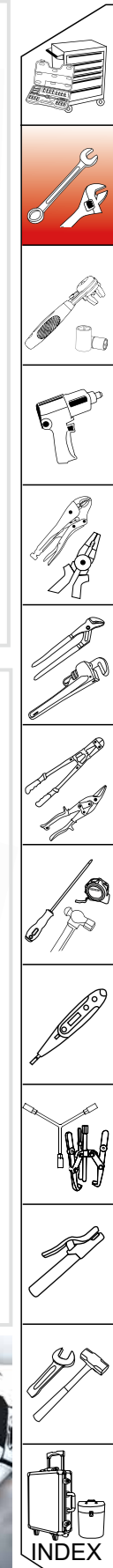

INDEX

可调式换头扭力扳手

Adjustable & Interchangeable Torque Wrench



货号 Item No.	头部尺寸 Size (mm)	扭力范围 Torque Range (N.m)	L(总长) length	装盒数 Pc/Box	单支重 NW/PC
M18120	9X12	2.0-10	284mm	1pc	0.58kg
M18121	9X12	5.0-30	303mm	1pc	0.72kg
M18122	9X12	20-100	427mm	1pc	0.94kg
M18123	14X18	40-200	460mm	1pc	1.06kg
M18124	14X18	65-335	520mm	1pc	1.20kg

- 整体热处理, 经久耐用
- 下拉式卡环调节扭力, 高效方便
- Overall heat treatment for durable use
- Pull-down collar to adjust torque for efficiency and convenience.

方头开口插件

Rectangular Open End Fitting

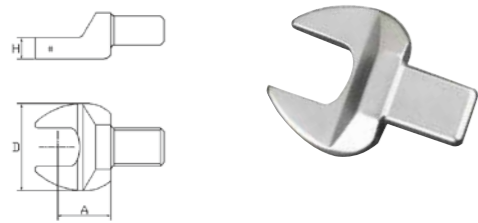

货号 Item No.	规格 Size	配方孔 Drive	A	H	D	装盒数 Pc/Box	单支重 NW/PC
M18911	7mm	9×12mm	17.5mm	5.5mm	22mm	1pc	0.038kg
M18912	8mm	9×12mm	17.5mm	5.5mm	22mm	1pc	0.037kg
M18913	9mm	9×12mm	17.5mm	6mm	25mm	1pc	0.044kg
M18914	10mm	9×12mm	17.5mm	6mm	25mm	1pc	0.043kg
M18915	11mm	9×12mm	17.5mm	6mm	25mm	1pc	0.042kg
M18916	12mm	9×12mm	17.5mm	7mm	29mm	1pc	0.048kg
M18917	13mm	9×12mm	17.5mm	7mm	29mm	1pc	0.047kg
M18918	14mm	9×12mm	17.5mm	8mm	33mm	1pc	0.058kg
M18919	15mm	9×12mm	17.5mm	8mm	33mm	1pc	0.057kg
M18920	16mm	9×12mm	17.5mm	8mm	38mm	1pc	0.056kg
M18921	17mm	9×12mm	17.5mm	8mm	38mm	1pc	0.054kg
M18922	18mm	9×12mm	25mm	8mm	42.5mm	1pc	0.080kg
M18923	19mm	9×12mm	25mm	8mm	42.5mm	1pc	0.075kg
M18936	17mm	14×18mm	25mm	9mm	38mm	1pc	0.127kg
M18937	18mm	14×18mm	25mm	10mm	42mm	1pc	0.138kg
M18938	19mm	14×18mm	25mm	10mm	42mm	1pc	0.137kg
M18939	21mm	14×18mm	25mm	12mm	48mm	1pc	0.158kg
M18940	22mm	14×18mm	25mm	12mm	48mm	1pc	0.155kg
M18941	24mm	14×18mm	25mm	13mm	52mm	1pc	0.159kg
M18942	27mm	14×18mm	30mm	14mm	57mm	1pc	0.230kg
M18943	30mm	14×18mm	35mm	14mm	65mm	1pc	0.255kg
M18944	32mm	14×18mm	35mm	14mm	65mm	1pc	0.255kg

- 品质卓越 · 通用尺寸方头, 适用多种复杂环境
- 小角度驱动寿命长
- 本品属于易耗品, 不属于终身保用范围
- High quality
- Ratchet system, small angle drive, long life
- No warranty as consumables

方头棘轮插件

Ratchet head

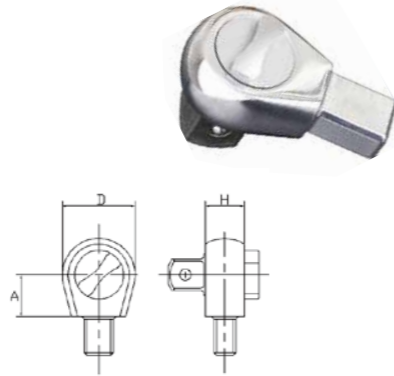

货号 Item No.	规格 Size	配方孔 Drive	A	H	D	装盒数 Pc/Box	单支重 NW/PC
M18890	1/4"	9×12mm	17.5mm	16.2mm	37mm	1pc	0.135kg
M18891	3/8"	9×12mm	17.5mm	21mm	38mm	1pc	0.160kg
M18892	1/2"	9×12mm	17.5mm	21mm	38mm	1pc	0.160kg
M18901	1/2"	14×18mm	25mm	21mm	40mm	1pc	0.265kg

- 品质卓越 · 通用尺寸方头, 适用多种复杂环境
- 小角度驱动寿命长
- 本品属于易耗品, 不属于终身保用范围
- High quality
- Ratchet system, small angle drive, long life
- No warranty as consumables

方头梅花插件

Rectangular Ring End Fitting

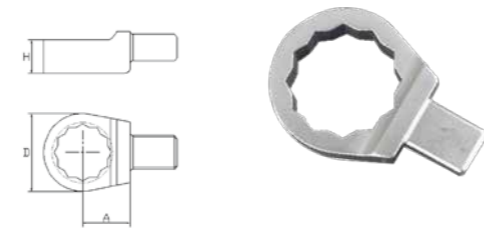

货号 Item No.	规格 Size	配方孔 Drive	A	H	D	装盒数 Pc/Box	单支重 NW/PC
M18957	7mm	9×12mm	17.5mm	8mm	22mm	1pc	0.043kg
M18958	8mm	9×12mm	17.5mm	8mm	22mm	1pc	0.042kg
M18959	9mm	9×12mm	17.5mm	9mm	22mm	1pc	0.045kg
M18960	10mm	9×12mm	17.5mm	9mm	22mm	1pc	0.048kg
M18961	11mm	9×12mm	17.5mm	9mm	22mm	1pc	0.047kg
M18962	12mm	9×12mm	17.5mm	12mm	22mm	1pc	0.054kg
M18963	13mm	9×12mm	17.5mm	12mm	22mm	1pc	0.053kg
M18964	14mm	9×12mm	17.5mm	12mm	23mm	1pc	0.052kg
M18965	15mm	9×12mm	17.5mm	12mm	25mm	1pc	0.054kg
M18966	16mm	9×12mm	17.5mm	13mm	27.5mm	1pc	0.056kg
M18967	17mm	9×12mm	17.5mm	13mm	27.5mm	1pc	0.055kg
M18968	18mm	9×12mm	17.5mm	13mm	29mm	1pc	0.058kg
M18969	19mm	9×12mm	17.5mm	13mm	31mm	1pc	0.057kg
M18971	21mm	9×12mm	17.5mm	13mm	33.5mm	1pc	0.068kg
M18972	22mm	9×12mm	17.5mm	13mm	35mm	1pc	0.073kg
M18982	17mm	14×18mm	25mm	12mm	32mm	1pc	0.127kg
M18983	18mm	14×18mm	25mm	12mm	32mm	1pc	0.133kg
M18984	19mm	14×18mm	25mm	12mm	32mm	1pc	0.138kg
M18985	21mm	14×18mm	25mm	15mm	33mm	1pc	0.148kg
M18986	22mm	14×18mm	25mm	15mm	35mm	1pc	0.154kg
M18987	24mm	14×18mm	25mm	15mm	38mm	1pc	0.160kg
M18988	27mm	14×18mm	30mm	17.5mm	41.5mm	1pc	0.160kg
M18989	30mm	14×18mm	30mm	17.5mm	45mm	1pc	0.165kg
M18990	32mm	14×18mm	30mm	17.5mm	47.5mm	1pc	0.168kg

- 品质卓越 · 通用尺寸方头, 适用多种复杂环境
- 小角度驱动寿命长
- 本品属于易耗品, 不属于终身保用范围
- High quality
- Ratchet system, small angle drive, long life
- No warranty as consumables

二合一数显扭力/胎压仪

Digital Torque Meter and Tire Pressure Gauge



货号 Item No.	规格 Size	驱动头 Square Drive	装盒数 Pc/Box	装箱数 Pc/Carton	单支重 NW/PC	毛重 GW/CTN
M18340	1/2"Dr.X75mm	1/2"	6pcs	24pcs	0.23kg	7.52kg



- 本产品同时具有扭力及胎压仪之功能
- 具备5种扭力单位选择, 4种压力单位选择
- 可以预置扭力具备50组记忆, 压力1组, 具有报警功能
- This product also has the function of torque and tire pressure meter
- With 5 kinds of torque unit selection, 4 kinds of pressure unit selection
- Torque can be preset, with 50 sets of memory, 1 set of pressure, alarm function

电子扭力联接器

Portable Torque Meter



货号 Item No.	规格 Size	驱动头 Square Drive	装盒数 Pc/Box	装箱数 Pc/Carton	单支重 NW/PC	毛重 GW/CTN
M18350	1/2"Dr.X75mm	1/2"	12pcs	48pcs	0.21kg	12.00kg



- 具备3种扭力单位选择
- 可以预置扭力, 具备50组记忆, 具有报警功能
- With 3 kinds of torque unit options
- Torque can be preset, with 50 sets of memory, with alarm function

指针式扭力扳手 镀铬

Torque Wrench

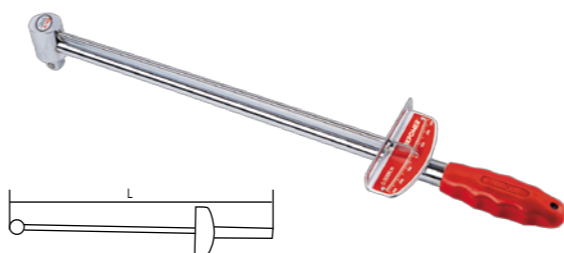

货号 Item No.	驱动头 Square Drive	扭力范围 Torque Range (N.m)	总长 (L)	装盒数 Pc/Box	装箱数 Pc/Carton	毛重 GW/CTN	单支重 NW/PC
M18111	1/2"	0-300	485	1pc	20pcs	20.70kg	0.900kg
M18112	3/4"	0-500	545	1pc	12pcs	21.30kg	1.583kg

- 采用优质合金钢制造而成, 镜面抛光双层镀铬
- 本品属于易耗品, 不属于终身保用范围
- Body drop forged with super alloy steel, High quality polished and chromed plated
- No warranty as consumables

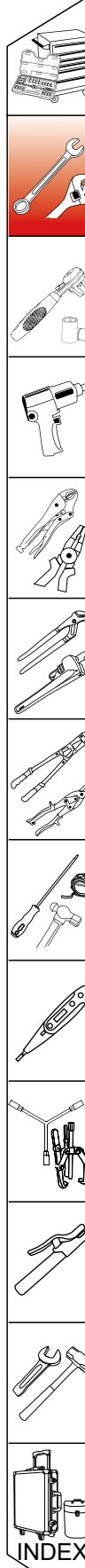
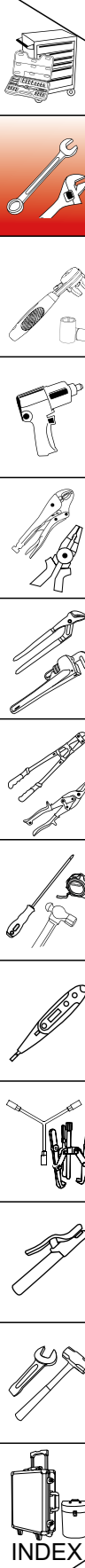

INDEX

INDEX

航空级流线型大开口扳手

Adjustable Wrench

专利



货号 Item No	规格 Size	L(总长) length	C(开口量) Opening Capacity	装盒数 Pc/Box	装箱数 Pc/ Carton	毛重 GW/CTN	单支重 NW/PC
M 11160	150mm(6")	150mm	24mm	6pcs	120pcs	21.30kg	0.160kg
M 11161	200mm(8")	200mm	29mm	6pcs	72pcs	23.30kg	0.300kg
M 11162	250mm(10")	250mm	34mm	6pcs	48pcs	22.90kg	0.460kg
M 11163	300mm(12")	300mm	41mm	6pcs	24pcs	17.00kg	0.720kg
M 11164	375mm(15")	380mm	45mm	4pcs	16pcs	20.90kg	1.220kg

- 专利产品 ZL200930020153.2 · 整体流线型人性化设计, 美观适用
- 整体优质合金钢锻造 · 整支产品经过特殊热处理
- 精密螺母, 开合自如 · 扳口上镭射刻度, 便于操作
- Patent products ZL200930020153.2 · Streamlined humanized design
- Body drop-forged with super alloy steel · Heat Treatment
- Precision nut, open and close easily
- With laser scale

加重型大开口活扳手

Heavy Duty Wide Opening Adjustable Wrench

专利

工业级



货号 Item No	规格 Size	L(总长) length	C(开口量) Opening Capacity	装盒数 Pc/Box	装箱数 Pc/ Carton	毛重 GW/CTN	单支重 NW/PC
M 11101	100mm(4")	109mm	13mm	12pcs	240pcs	14.50kg	0.050kg
M 11102	150mm(6")	160mm	24mm	6pcs	120pcs	20.00kg	0.160kg
M 11103	200mm(8")	210mm	30mm	6pcs	60pcs	18.00kg	0.270kg
M 11104	250mm(10")	260mm	35mm	6pcs	36pcs	17.30kg	0.450kg
M 11105	300mm(12")	310mm	41mm	6pcs	24pcs	18.60kg	0.720kg

- 专利产品 ZL03313668.8 · 整体优质合金钢锻造 · 扳口上镭射刻度, 便于操作
- 高精度螺母, 开合自如
- 产品整支热处理, 扭矩超美国 ASME 标准 30% 以上, 开口量增加 20% 以上
- Patent products ZL03313668.8 · Body drop-forged with super alloy steel
- Precision nut, open and close easily · With laser metric or SAE scale
- Body heat treatment torque can exceed ASME standard 30%, wide opening capacity can increase over 20%.

锥形活扳手

Adjustable Wrench

工业级



货号 Item No	规格 Size	L(总长) length	C(开口量) Opening Capacity	装盒数 Pc/Box	装箱数 Pc/ Carton	毛重 GW/CTN	单支重 NW/PC
M 11106	375mm(15")	378mm	45mm	1pc	20pcs	28.00kg	1.29kg
M 11107	450mm(18")	458mm	55mm	1pc	12pcs	25.00kg	1.92kg
M 11108	600mm(24")	602mm	62mm	1pc	6pcs	19.20kg	2.90kg
M 11109	750mm(30")	752mm	85mm	1pc	3pcs	18.50kg	5.90kg

- 整体优质合金钢锻造 · 高精度螺母, 开合自如 · 扳口上镭射刻度, 便于操作
- 产品整支热处理, 扭矩超美国 ASME 标准 30% 以上
- 尾部变窄, 便于套管工作, 但注意不能超负荷工作
- Body drop-forged with super alloy steel · Precision nut, open and close easily
- With laser metric or SAE scale
- Body heat treatment torque can exceed ASME standard 30%
- Narrower end, easy to add pipe to work, but can not be overloaded with work

超薄大开口活扳手

Stubby Adjustable Wrench with Jaws



货号 Item No	规格 Size	L(总长) length	C(开口量) Opening Capacity	装盒数 Pc/Box	装箱数 Pc/ Carton	毛重 GW/CTN	单支重 NW/PC
M 11180	120mm	120 mm	24 mm	6pcs	120pcs	13.70kg	0.085kg
M 11181	140mm	140 mm	30 mm	6pcs	60pcs	11.50kg	0.150kg

- 头部尖端超薄加工, 适用于更小更狭窄的空间
- Ultra thin processing at the tip of the head for smaller and narrower spaces

欧式活扳手

Adjustable Wrench



货号 Item No	规格 Size	总长 length	开口量 Opening Capacity	装盒数 Pc/Box	装箱数 Pc/ Carton	毛重 GW/CTN	单支重 NW/PC
M 11133	100(4")	102	13	12	240	13.00	0.048
M 11134	150(6")	153	19.3	6	96	14.00	0.134
M 11135	200(8")	204	24	6	60	16.00	0.244
M 11136	250(10")	254	29	6	48	20.00	0.388
M 11137	300(12")	305	34	6	36	25.00	0.656
M 11138	375(15")	381	45	1	12	17.50	1.328

- 欧式15度偏角
- 整体优质合金钢锻造
- 高精度螺母, 开合自如
- European Type 15°
- Body drop-forged with super alloy steel
- Precision nut, open and close easily

大力活扳手

Locking Adjustable Wrench

NEW

CR-V



货号 Item No	规格 Size	L(总长) length	开口量 Opening Capacity	装盒数 Pc/Box	装箱数 Pc/ Carton	毛重 GW/CTN	单支重 NW/PC
M 11681	250mm(10")	250mm	33mm	6pcs	36pcs	23.20kg	0.58kg

- 嘴部带齿防滑设计
- 锁紧机构, 可夹紧公英制紧固件及圆形紧固件
- 手柄设计可以快速打开和锁紧
- Non-Slip Design with Teeth
- Locking Mechanism, Allows for gripping on both inch and metric fasteners, including rounded fasteners
- Release Lever, Allows for easy disengagement of locking mechanism

棘轮快速活扳手

Ratchet Function Adjustable Wrench

专利



货号 Item No	规格 Size	L(总长) length	开口量 Opening Capacity	装盒数 Pc/Box	装箱数 Pc/ Carton	毛重 GW/CTN	单支重 NW/PC
M 11689	250mm(10")	256 mm	30mm	6pcs	48pcs	24.00kg	0.36kg
M 11690	300mm(12")	306 mm	36mm	6pcs	36pcs	28.30kg	0.60kg

- 专利产品 ZL201320638052.2
- 一次性夹紧, 无需多次调整, 快速功能方便快捷, 节省时间
- Patent products ZL201320638052.2
- Ratchet adjustable wrench, with quick withdrawal function, wide opening.

专业级活扳手

Adjustable Wrench



货号 Item No	规格 Size	L(总长) length	C(开口量) Opening Capacity	装盒数 Pc/Box	装箱数 Pc/ Carton	毛重 GW/CTN	单支重 NW/PC
M 11112	100mm(4")	108mm	13mm	12pcs	240pcs	14.20kg	0.046kg
M 11113	150mm(6")	158mm	19.3mm	6pcs	120pcs	16.00kg	0.130kg
M 11114	200mm(8")	208mm	24mm	6pcs	96pcs	25.00kg	0.220kg
M 11115	250mm(10")	258mm	29mm	6pcs	60pcs	27.00kg	0.420kg
M 11116	300mm(12")	308mm	34mm	6pcs	36pcs	23.80kg	0.600kg
M 11117	375mm(15")	381mm	45mm	1pc	20pcs	26.00kg	1.200kg
M 11118	450mm(18")	454mm	55mm	1pc	12pcs	23.00kg	1.830kg
M 11119	600mm(24")	610mm	62mm	1pc	4pcs	12.70kg	2.800kg

- 高精度螺母, 开合自如
- 扳口上镭射刻度, 便于操作
- Precision nut, open and close easily
- With laser metric or SAE scale

汽车扳手

Adjustable Auto Wrench



货号 Item No	规格 Size	L(总长) length	C(开口量) Opening Capacity	装盒数 Pc/Box	装箱数 Pc/ Carton	毛重 GW/CTN	单支重 NW/PC
M 11778	230mm(9")	230mm	62mm	5pcs	30pcs	24.60kg	0.800kg
M 11779	280mm(11")	280mm	78mm	5pcs	30pcs	25.60kg	0.810kg
M 11780	375mm(15")	375mm	82mm	2pcs	12pcs	19.30kg	1.540kg

- 整支热处理, 双层镀铬处理 · 开口量特大, 适用于装卸大螺帽和管道件安装等
- Heat Treatment, High quality polished and chromed plated
- Super wide opening, suitable to load and unload big screw and also for pipeline installation

四合一多功能活扳手

4in1 Multifunction Adjustable construction Wrench

NEW



货号 Item No	规格 Size	L(总长) length	C(开口量) Opening Capacity	装盒数 Pc/Box	装箱数 Pc/ Carton	毛重 GW/CTN	单支重 NW/PC
M11453	300mm(12")	405mm	34mm	6pcs	24pcs	25.00kg	1.03kg

- 此产品具锤子、扳手、管钳、撬杠四种功能
- 整体优质合金钢锻造
- 精密螺母, 开合自如
- This product has functions of an adjustable wrench, pipe wrench, hammer and spud wrench.
- Body drop-forged with alloy steel
- Precision nut open and close easily

多功能锤式胶柄活扳手

Multi Function Wide Opening Adjustable Wrench

专利

工业级

CR-V



货号 Item No	规格 Size	总长 length	开口量 Opening Capacity	装盒数 Pc/Box	装箱数 Pc/ Carton	毛重 GW/CTN	单支重 NW/PC
M 11432	250mm(10")	258mm	35mm	6pcs	48pcs	27.40kg	0.54kg
M 11433	300mm(12")	308mm	40mm	6pcs	36pcs	30.00kg	0.83kg

- 专利产品 ZL200830012937.6
- 此产品具锤子、扳手、管钳三种功能
- 整体优质合金钢锻造
- 精密螺母, 开合自如
- 扳口上镭射刻度, 便于操作
- 胶柄采用无毒材料, 符合欧盟标准
- Patent products ZL200830012937.6
- Head has function of 3 products—hammer, adjustable wrench and pipe wrench
- Body drop-forged with alloy steel · Precision nut open and close easily
- With laser metric or SAE scale · Grip with no-toxic material, meet EU standard

大开口塑柄活扳手
Adjustable Wrench



货号 Item No	规格 Size	L(总长) length	C(开口量) Opening Capacity	装盒数 Pc/Box	装箱数 Pc/Carton	毛重 GW/CTN	单支重 NW/PC
M 11366	150mm(6")	160mm	24mm	6pcs	72pcs	11.00kg	0.155kg
M 11367	200mm(8")	210mm	30mm	6pcs	60pcs	17.80kg	0.270kg
M 11368	250mm(10")	260mm	35mm	6pcs	48pcs	22.80kg	0.440kg
M 11369	300mm(12")	310mm	41mm	6pcs	36pcs	28.70kg	0.720kg

- 专利产品 ZL03313667.X · 大开口活扳手, 双色胶柄, 握感舒适
- 整体优质合金钢锻造 · 高精度螺母, 开合自如 · 扳口上镭射刻度, 便于操作
- 胶柄采用无毒材料, 符合欧盟标准 · 尾部梅花孔, 可代替同规格的梅花扳手
- 表面采用镍铁工艺处理
- Patent products ZL03313667.X
- Wide opening adjustable wrench, with double color comfortable grip
- Body drop-forged with alloy steel · Precision nut open and close easily
- With laser metric or SAE scale · Grip with no-toxic material, meet EU standard
- Box end, can replace box end wrench with the same size
- Iron nickel finish

多功能大开口塑柄活扳手
Multi Function Wide Opening Adjustable Wrench



货号 Item No	规格 Size	L(总长) length	C(开口量) Opening Capacity	装盒数 Pc/Box	装箱数 Pc/Carton	毛重 GW/CTN	单支重 NW/PC
M 11421	150mm(6")	160mm	24mm	6pcs	72pcs	14.00kg	0.170kg
M 11422	200mm(8")	210mm	30mm	6pcs	60pcs	17.70kg	0.270kg
M 11423	250mm(10")	260mm	35mm	6pcs	48pcs	23.70kg	0.460kg
M 11424	300mm(12")	310mm	41mm	6pcs	36pcs	28.80kg	0.740kg

- 专利产品 ZL03313667.X
- 多功能大开口活扳手, 双材料胶柄, 握感舒适
- 整体优质合金钢锻造 · 扳口上镭射刻度, 便于操作
- 高精度螺母, 开合自如 · 胶柄采用无毒材料, 符合欧盟标准
- 尾部梅花孔, 可代替同规格的梅花扳手 · 表面采用镍铁工艺处理
- Patent products ZL03313667.X
- Multi function wide opening adjustable wrench, with double color comfortable grip
- Body drop-forged with alloy steel
- Precision nut open and close easily With laser metric or SAE scale
- Grip made of non-toxic material, meet EU standard
- Box end can work as box end wrench Nickel plated finish

超大开口轻型胶柄活扳手
Wide Opening Adjustable Wrench



货号 Item No	规格 Size	L(总长) length	C(开口量) Opening Capacity	装盒数 Pc/Box	装箱数 Pc/Carton	毛重 GW/CTN	单支重 NW/PC
M 11719	200mm(8")	218mm	40mm	6pcs	60pcs	21.80kg	0.343kg
M 11720	250mm(10")	257mm	52mm	6pcs	36pcs	21.50kg	0.531kg

- 多功能超大开口活扳手, 双材料胶柄, 握感舒适
- 整体优质合金钢锻造, 坚固耐用
- 精密螺母, 开合自如
- 扳口上镭射刻度, 便于操作
- 胶柄采用无毒材料, 符合欧盟标准
- Precision nut open and close easily
- Multi function wide opening adjustable wrench, with double color comfortable grip
- Body drop-forged with alloy steel
- With laser metric or SAE scale
- Grip with no-toxic material, meet EU standard

超大开口活扳手
Adjustable Wrench



货号 Item No	规格 Size	L(总长) length	开口量 Opening Capacity	装盒数 Pc/Box	装箱数 Pc/Carton	毛重 GW/CTN	单支重 NW/PC
M 11375	150(6")	165mm	34mm	6pcs	120pcs	21.00kg	0.170kg
M 11376	200(8")	214mm	39mm	6pcs	60pcs	19.00kg	0.280kg
M 11377	250(10")	255mm	50mm	6pcs	36pcs	20.00kg	0.530kg
M 11378	300(12")	308mm	60mm	6pcs	24pcs	20.20kg	0.800kg

- 超大开口设计
- 狭长的钳嘴适合狭窄的空间使用
- 精密螺母, 开合自如
- Wide opening adjustable wrench
- Thinner and longer jaws for narrow space working.
- Precision nut open and close easily.

锤式活扳手
Adjustable Wrench



货号 Item No	规格 Size	L(总长) length	开口量 Opening Capacity	装盒数 Pc/Box	装箱数 Pc/Carton	毛重 GW/CTN	单支重 NW/PC
M 11456	450mm(18")	452mm	55mm	1pc	12pcs	24.40kg	1.892kg

- 此产品具锤子、扳手两种功能
- 整体优质合金钢锻造 · 精密螺母, 开合自如 · 扳口上镭射刻度, 便于操作
- Head has function of 2 products-hammer, adjustable wrench
- Body drop-forged with super alloy steel
- Precision nut open and close easily · With laser metric or SAE scale

L型套筒扳手
L Wrench

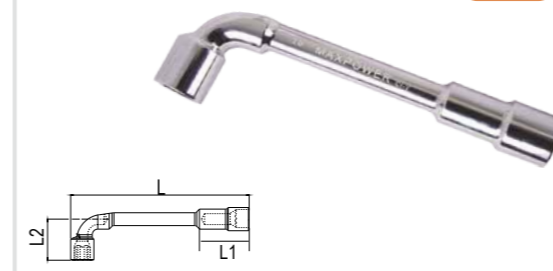

货号 Item No	规格 Size	L(总长) length	L1	L2	装盒数 Pc/Box	装箱数 Pc/Carton	毛重 GW/CTN	单支重 NW/PC
M 48806	6mm	102mm	24.6mm	24mm	40pcs	240pcs	8.60kg	0.030kg
M 48807	7mm	106mm	26.3mm	26mm	40pcs	240pcs	11.50kg	0.040kg
M 48808	8mm	114mm	29.8mm	29.5mm	25pcs	150pcs	10.00kg	0.060kg
★ M 48809	9mm	122mm	31.4mm	31mm	25pcs	150pcs	11.20kg	0.070kg
M 48810	10mm	129mm	34.5mm	36mm	25pcs	150pcs	14.50kg	0.090kg
★ M 48811	11mm	136mm	36.0mm	37.5mm	20pcs	120pcs	14.20kg	0.110kg
M 48812	12mm	144mm	42.1mm	40mm	20pcs	120pcs	19.00kg	0.150kg
M 48813	13mm	152mm	43.6mm	42mm	20pcs	120pcs	21.40kg	0.170kg
M 48814	14mm	160mm	46.4mm	44.5mm	18pcs	72pcs	15.90kg	0.210kg
M 48815	15mm	169mm	48.1mm	47mm	18pcs	72pcs	16.60kg	0.220kg
M 48816	16mm	178mm	54.7mm	51mm	12pcs	48pcs	14.80kg	0.290kg
M 48817	17mm	187mm	56.8mm	53mm	12pcs	48pcs	15.20kg	0.300kg
M 48818	18mm	195mm	58.4mm	54mm	12pcs	48pcs	15.70kg	0.310kg
M 48819	19mm	204mm	61.0mm	57mm	12pcs	48pcs	21.20kg	0.420kg
★ M 48820	20mm	212mm	62.2mm	59mm	12pcs	48pcs	23.60kg	0.450kg
M 48821	21mm	221mm	64.9mm	62mm	10pcs	40pcs	19.80kg	0.470kg
M 48822	22mm	230mm	67.2mm	64mm	10pcs	40pcs	22.60kg	0.540kg
★ M 48823	23mm	240mm	77.2mm	67.5mm	8pcs	32pcs	22.10kg	0.660kg
M 48824	24mm	250mm	78.7mm	71mm	8pcs	32pcs	22.50kg	0.680kg
★ M 48825	25mm	260mm	81.2mm	75mm	6pcs	24pcs	20.40kg	0.810kg
★ M 48826	26mm	270mm	82.7mm	77.5mm	8pcs	24pcs	21.70kg	0.860kg
M 48827	27mm	280mm	85.9mm	78mm	8pcs	24pcs	25.10kg	1.000kg
★ M 48828	28mm	290mm	87.0mm	80mm	6pcs	18pcs	20.20kg	1.060kg
★ M 48829	29mm	300mm	87.0mm	82mm	6pcs	18pcs	19.40kg	1.070kg
M 48830	30mm	310mm	95.7mm	86mm	6pcs	18pcs	22.90kg	1.210kg
★ M 48831	31mm	320mm	98.1mm	92mm	5pcs	15pcs	20.10kg	1.260kg
M 48832	32mm	330mm	99.0mm	92mm	5pcs	15pcs	23.50kg	1.420kg
★ M 48833	33mm	340mm	105.7mm	101mm	2pcs	12pcs	19.00kg	1.480kg
M 48834	34mm	350mm	107.2mm	102mm	2pcs	12pcs	19.80kg	1.550kg
★ M 48835	35mm	360mm	108.3mm	103mm	2pcs	12pcs	19.90kg	1.560kg
M 48836	36mm	370mm	110.5mm	104mm	2pcs	12pcs	21.00kg	1.650kg
★ M 48838	38mm	390mm	117.2mm	110mm	2pcs	12pcs	26.50kg	2.110kg

带★标为不常用规格

- 工业级精度和强度, 铬钒钢锻造, 使用时不受螺丝长度影响, 使用范围更广泛
- With industry precision and strength, forged with CRV steel, don't influenced by the length of the screw



工业级加长两用扳手
Long Combination Wrench

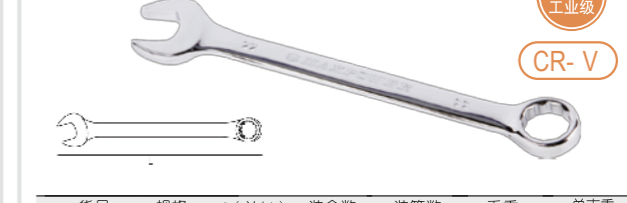

货号 Item No	规格 Size	L(总长) length	装盒数 Pc/Box	装箱数 Pc/Carton	毛重 GW/CTN	单支重 NW/PC
M 14207	6mm	126mm	10pcs	200pcs	4.50kg	0.022kg
M 14208	7mm	127mm	10pcs	200pcs	5.50kg	0.022kg
M 14209	8mm	140mm	10pcs	200pcs	7.50kg	0.033kg
★ M 14210	9mm	150mm	10pcs	200pcs	9.50kg	0.043kg
M 14211	10mm	160mm	10pcs	200pcs	11.00kg	0.051kg
M 14212	11mm	166mm	10pcs	200pcs	16.50kg	0.077kg
M 14213	12mm	170mm	10pcs	200pcs	16.50kg	0.078kg
M 14214	13mm	178mm	10pcs	200pcs	17.50kg	0.090kg
M 14215	14mm	190mm	5 pcs	160pcs	17.00kg	0.101kg
M 14216	15mm	198mm	5 pcs	150pcs	18.00kg	0.113kg
M 14217	16mm	208mm	5 pcs	150pcs	20.00kg	0.128kg
M 14218	17mm	224mm	5 pcs	150pcs	27.00kg	0.173kg
M 14219	18mm	235mm	5 pcs	140pcs	26.00kg	0.183kg
M 14220	19mm	248mm	5 pcs	120pcs	25.00kg	0.202kg
★ M 14221	20mm	250mm	5 pcs	100pcs	21.00kg	0.200kg
M 14222	21mm	272mm	5 pcs	100pcs	24.00kg	0.235kg
M 14223	22mm	292mm	5 pcs	100pcs	31.00kg	0.300kg
★ M 14224	23mm	295mm	5 pcs	80pcs	25.00kg	0.298kg
M 14225	24mm	312mm	5 pcs	80pcs	35.00kg	0.303kg
M 14228	27mm	335mm	5 pcs	80pcs	35.00kg	0.488kg
M 14231	30mm	354mm	5 pcs	30pcs	18.00kg	0.567kg
M 14233	32mm	375mm	5 pcs	30pcs	21.50kg	0.687kg

带★标为不常用规格

- 精抛光双层镀铬处理, 防锈能力强
- 整体铬钒钢锻造而成, 坚固耐用
- High quality polished and chromed plated, anti-rust good
- Body drop forged with CRV

工业级加长两用扳手8、10、14、23件套
8pcs/10pcs/14pcs/23pcs Combination Wrench Set



货号 Item No	规格 Size	装盒数 Pc/Box	装箱数 Pc/Carton	毛重 GW/CTN	每套重量 Weight Per Set
M 07217	8-22mmx8pcs	1set	20sets	21.50kg	1.00kg
M 07218	8-27mmx10pcs	1set	10sets	19.30kg	1.78kg
M 09026	8-24mmx14pcs	1set	10sets	22.00kg	2.10kg
M 07219	6-32mmx14pcs	1set	5sets	18.00kg	3.40kg
M 09027	6-32mmx23pcs	1set	5sets	28.60kg	5.60kg

- Size: 8pcs: 8, 9, 10, 12, 14, 17, 19, 22mm
- 10pcs: 8, 9, 10, 12, 14, 17, 19, 22, 24, 27mm
- 14pcs: 8, 9, 10, 11, 12, 13, 14, 15, 16, 17, 19, 21, 22, 24mm
- 6, 8, 10, 11, 12, 13, 14, 17, 19, 21, 24, 27, 30, 32mm
- 23pcs: 6, 7, 8, 9, 10, 11, 12, 13, 14, 15, 16, 17, 18, 19, 20, 21, 22, 23, 24, 25, 27, 30, 32
- 包装坚固耐用, 方便携带
- 整体铬钒钢锻造而成, 精抛光镀铬
- Durable Packaging, Easy to carry
- Body drop forged with CRV, High quality polished and chromed plated

工业级加长梅花扳手 Long Double Box End Wrench

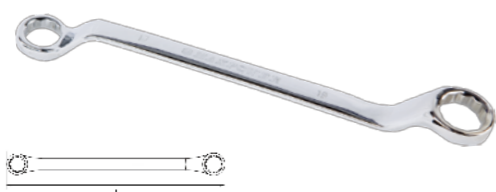

货号 Item No	规格 Size	L(总长) length	装盒数 Pc/Box	装箱数 Pc/Carton	毛重 GW/CTN	单支重 NW/PC
M12202	5.5x7mm	160mm	10pcs	200pcs	10.50kg	0.047kg
M12204	8x10mm	175mm	10pcs	200pcs	14.00kg	0.066kg
M12205	9x11mm	191mm	10pcs	200pcs	21.00kg	0.100kg
M12206	10x12mm	191mm	10pcs	200pcs	21.00kg	0.100kg
M12208	12x14mm	210mm	5pcs	200pcs	27.00kg	0.130kg
M12209	13x15mm	232mm	5pcs	200pcs	36.00kg	0.175kg
M12210	13x16mm	232mm	5pcs	200pcs	36.00kg	0.175kg
M12211	14x17mm	232mm	5pcs	200pcs	36.00kg	0.175kg
M12212	16x18mm	232mm	5pcs	200pcs	36.00kg	0.175kg
M12213	17x19mm	248mm	5pcs	100pcs	23.00kg	0.225kg
M12214	18x21mm	272mm	5pcs	80pcs	23.00kg	0.278kg
M12215	19x21mm	278mm	5pcs	80pcs	23.00kg	0.278kg
M12216	19x22mm	278mm	5pcs	80pcs	23.00kg	0.278kg
M12218	22x24mm	320mm	5pcs	50pcs	20.00kg	0.380kg
M12220	24x27mm	370mm	5pcs	50pcs	29.00kg	0.560kg
M12221	27x30mm	395mm	5pcs	40pcs	25.50kg	0.615kg
M12222	30x32mm	415mm	5pcs	25pcs	17.50kg	0.660kg

- 精抛光双层镀铬处理, 防锈能力强
- 整体铬钒钢锻造而成, 坚固耐用
- High quality polished and chromed plated, antirust good
- Body drop forged with CRV

工业级加长梅花扳手 8、10、11 件套 8pcs/10pcs/11pcs Long Double Box End Wrench Set



货号 Item No	规格 Size	装盒数 Pc/Box	装箱数 Pc/Carton	毛重 GW/CTN	每套重量 Weight Per Set
M 09011	5.5-27mmx8pcs	1set	20sets	34.00kg	1.65kg
M 09012	5.5-32mmx10pcs	1set	10sets	27.50kg	2.60kg
M 09028	8-27mmx11pcs	1set	10sets	30.50kg	2.96kg

Size: 8pcs: 5.5x7, 8x10, 10x12, 12x14, 14x17, 17x19, 19x22, 24x27mm
10pcs: 5.5x7, 8x10, 9x11, 10x12, 12x14, 14x17, 17x19, 19x22, 24x27, 30x32mm
11PCS: 8x10, 10x12, 11x13, 12x14, 14x17, 17x19, 19x21, 21x23, 22x24, 23x26, 24x27

- 包装坚固耐用, 方便携带
- 整体铬钒钢锻造而成, 精抛光镀铬
- Durable Packaging, Easy to carry
- Body drop forged with CRV, High quality polished and chromed plated

工业级加长双头呆扳手 Long Double Open End Wrench

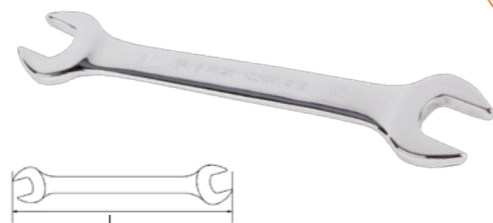

货号 Item No	规格 Size	L(总长) length	装盒数 Pc/Box	装箱数 Pc/Carton	毛重 GW/CTN	单支重 NW/PC
M 13203	6x7mm	126mm	10pcs	200pcs	6.00kg	0.025kg
M 13204	8x10mm	145mm	10pcs	200pcs	9.00kg	0.041kg
M 13205	9x11mm	163mm	10pcs	200pcs	11.00kg	0.053kg
M 13206	10x12mm	163mm	10pcs	200pcs	12.00kg	0.058kg
M 13208	12x14mm	181mm	10pcs	200pcs	18.00kg	0.085kg
M 13209	13x15mm	189mm	10pcs	200pcs	23.00kg	0.110kg
M 13210	13x16mm	189mm	10pcs	200pcs	23.00kg	0.110kg
M 13211	14x17mm	199mm	10pcs	200pcs	23.00kg	0.110kg
M 13212	16x18mm	199mm	10pcs	200pcs	26.00kg	0.125kg
M 13213	17x19mm	221mm	5pcs	150pcs	30.00kg	0.193kg
M 13214	18x21mm	221mm	5pcs	120pcs	31.00kg	0.252kg
M 13216	19x22mm	240mm	5pcs	120pcs	31.00kg	0.252kg
M 13218	22x24mm	260mm	5pcs	120pcs	39.00kg	0.322kg
M 13220	24x27mm	287mm	5pcs	80pcs	35.00kg	0.428kg
M 13221	27x30mm	298mm	5pcs	50pcs	25.00kg	0.490kg
M 13222	30x32mm	311mm	5pcs	50pcs	32.00kg	0.620kg

- 精抛光双层镀铬处理, 防锈能力强
- 整体铬钒钢锻造而成, 坚固耐用
- High quality polished and chromed plated, antirust good
- Body drop forged with CRV

工业级加长双头呆扳手 8、10、13 件套 8pcs/10pcs/13pcs Long Double Open End Wrench Set



货号 Item No	规格 Size	装盒数 Pc/Box	装箱数 Pc/Carton	毛重 GW/CTN	每套重量 Weight Per Set
M 09009	6-24mmx8pcs	1set	25sets	33.00kg	1.30kg
M 09010	6-32mmx10pcs	1set	15sets	32.00kg	2.10kg
M 09029	6-32mmx13pcs	1set	10sets	27.00kg	2.55kg

Size: 8pcs: 6x7, 8x10, 10x12, 12x14, 14x17, 17x19, 19x22, 22x24mm
10pcs: 6x7, 8x10, 10x12, 12x14, 14x17, 17x19, 19x22, 22x24, 24x27, 30x32mm
13pcs: 6x7, 8x10, 10x12, 11x13, 12x14, 14x17, 17x19, 19x21, 21x23, 22x24, 23x26, 24x27, 30x32mm

- 包装坚固耐用, 方便携带
- 整体铬钒钢锻造而成, 精抛光镀铬
- Durable Packaging, Easy to carry
- Body drop forged with CRV, High quality polished and chromed plated

工业级棘轮两用扳手 Ratcheting Combination Wrench

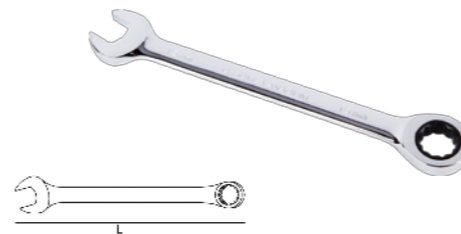

货号 Item No	规格 Size	L(总长) length	装盒数 Pc/Box	装箱数 Pc/Carton	毛重 GW/CTN	单支重 NW/PC
M 15208	8mm	140mm	10pcs	120pcs	8.00kg	0.042kg
M 15209	9mm	150mm	10pcs	120pcs	8.00kg	0.054kg
M 15210	10mm	160mm	10pcs	120pcs	11.00kg	0.067kg
M 15211	11mm	165mm	10pcs	120pcs	11.00kg	0.078kg
M 15212	12mm	170mm	10pcs	120pcs	15.00kg	0.071kg
M 15213	13mm	180mm	10pcs	120pcs	15.00kg	0.100kg
M 15214	14mm	190mm	10pcs	120pcs	14.00kg	0.117kg
M 15215	15mm	200mm	10pcs	60pcs	10.00kg	0.133kg
M 15216	16mm	210mm	10pcs	60pcs	11.00kg	0.167kg
M 15217	17mm	225mm	5pcs	60pcs	13.00kg	0.175kg
M 15218	18mm	235mm	5pcs	60pcs	13.00kg	0.225kg
M 15219	19mm	245mm	5pcs	60pcs	15.00kg	0.250kg
M 15220	20mm	245mm	5pcs	60pcs	16.00kg	0.242kg
M 15221	21mm	290mm	5pcs	60pcs	26.00kg	0.200kg
M 15222	22mm	290mm	5pcs	60pcs	25.00kg	0.333kg
M 15223	23mm	290mm	5pcs	45pcs	16.50kg	0.333kg
M 15224	24mm	332mm	5pcs	45pcs	24.40kg	0.510kg
M 15225	25mm	332mm	5pcs	45pcs	24.00kg	0.500kg
M 15226	26mm	359mm	5pcs	30pcs	20.80kg	0.650kg
M 15227	27mm	359mm	5pcs	30pcs	20.70kg	0.650kg
M 15228	28mm	359mm	5pcs	30pcs	20.40kg	0.633kg
M 15230	30mm	404mm	5pcs	24pcs	22.90kg	0.896kg
M 15232	32mm	424mm	5pcs	24pcs	27.30kg	1.083kg

- 铬钒钢整支锻造, 热处理
- 表面精抛光, 双层镀铬, 防锈能力强
- 棘轮精密, 使用寿命更长
- 72齿棘轮装置提高工作效率
- 本品属于易耗品, 不属于终身保用范围
- Body drop forged with CRV, Heat Treatment
- High quality polished and chromed plated, antirust good
- Precision ratchet, longer effective life
- Ratchet function can improve working efficiency
- No warranty as consumables

工业级棘轮两用扳手12件套 12PCS Ratcheting Combination Wrench Set



货号 Item No	规格 Size	装盒数 Pc/Box	装箱数 Pc/Carton	毛重 GW/CTN	每套重量 Weight Per Set
M 07250	8-19mmx12pcs	5sets	10sets	16.50kg	1.50kg

Size: 8, 9, 10, 11, 12, 13, 14, 15, 16, 17, 18, 19mm

- 铬钒钢整支锻造, 热处理
- 表面精抛光, 双层镀铬, 防锈能力强
- 棘轮精密, 使用寿命更长
- 72齿棘轮装置提高工作效率
- 本品属于易耗品, 不属于终身保用范围
- Body drop forged with CRV, Heat Treatment
- High quality polished and chromed plated, antirust good
- Precision ratchet, longer effective life
- Ratchet function can improve working efficiency
- No warranty as consumables

专业级加长双梅花扳手 Double Box End Wrench



货号 Item No	规格 Size	L(总长) length	装盒数 Pc/Box	装箱数 Pc/Carton	毛重 GW/CTN	单支重 NW/PC
M 12101	5.5 x 7mm	118mm	20pcs	200pcs	6.00kg	0.026kg
M 12103	8 x 10mm	138mm	20pcs	200pcs	8.00kg	0.036kg
M 12104	9 x 11mm	167mm	20pcs	200pcs	13.00kg	0.060kg
M 12105	10 x 12mm	167mm	20pcs	200pcs	12.50kg	0.058kg
M 12107	12 x 14mm	190mm	10pcs	200pcs	17.00kg	0.080kg
M 12108	13 x 15mm	212mm	5pcs	200pcs	25.00kg	0.125kg
M 12109	13 x 16mm	212mm	5pcs	200pcs	25.00kg	0.120kg
M 12110	14 x 17mm	216mm	5pcs	200pcs	26.00kg	0.125kg
M 12111	16 x 18mm	219mm	5pcs	200pcs	27.50kg	0.130kg
M 12112	17 x 19mm	260mm	5pcs	100pcs	19.00kg	0.175kg
M 12113	18 x 21mm	269mm	5pcs	80pcs	25.00kg	0.288kg
M 12115	19 x 22mm	275mm	5pcs	80pcs	23.00kg	0.281kg
M 12117	22 x 24mm	295mm	5pcs	50pcs	17.00kg	0.280kg
M 12119	24 x 27mm	341mm	5pcs	50pcs	21.50kg	0.400kg
M 12120	27 x 30mm	395mm	5pcs	40pcs	24.00kg	0.563kg
M 12121	30 x 32mm	410mm	5pcs	25pcs	18.00kg	0.640kg
M 12122	30 x 34mm	425mm	5pcs	25pcs	20.00kg	0.660kg
M 12124	32 x 36mm	445mm	5pcs	25pcs	20.00kg	0.720kg
M 12125	34 x 36mm	445mm	5pcs	25pcs	24.00kg	0.760kg
M 12126	36 x 41mm	457mm	5pcs	20pcs	21.00kg	0.950kg
M 12127	41 x 46mm	472mm	5pcs	20pcs	29.00kg	1.225kg
★ M 12128	46 x 50mm	483mm	5pcs	20pcs	31.00kg	1.375kg
★ M 12129	50 x 55mm	515mm	2pcs	10pcs	18.00kg	2.250kg

- 精抛光双层镀铬处理, 防锈能力强
- 整体优钢锻造而成, 坚固耐用
- 本品属于易耗品, 不属于终身保用范围
- High quality polished and chromed plated, antirust good
- Whole body drop forged with high quality steel for durable use
- No warranty as consumables

专业级加长双梅花扳手8、10件套 8PCS/10PCS Professional Long Double Box End Wrench Set



货号 Item No	规格 Size	装盒数 Pc/Box	装箱数 Pc/Carton	毛重 GW/CTN	每套重量 Weight Per Set
M 07221	5.5-27mm x 8pcs	1set	20sets	24.50kg	1.20kg
M 07222	5.5-32mm x 10pcs	1set	10sets	27.00kg	2.40kg

Size: 8pcs: 5.5 x 7.8 x 10, 10 x 12, 12 x 14, 14 x 17, 17 x 19, 19 x 22, 24 x 27mm
10pcs: 5.5 x 7.8 x 10, 9 x 11, 10 x 12, 12 x 14, 14 x 17, 17 x 19, 19 x 22, 24 x 27, 30 x 32mm

- 包装坚固耐用, 方便携带
- 整体优钢锻造, 精抛光镀铬
- 本品属于易耗品, 不属于终身保用范围
- Durable Packaging, Easy to carry
- Drop forged, High quality polished and chromed plated
- No warranty as consumables

专业级加长两用扳手 Combination Wrench



货号 Item No	规格 Size	L(总长) length	装盒数 Pc/Box	装箱数 Pc/Carton	毛重 GW/CTN	单支重 NW/PC
M 14106	6mm	101mm	20pcs	240pcs	5.00kg	0.022kg
M 14108	8mm	120mm	20pcs	240pcs	8.00kg	0.031kg
★ M 14109	9mm	130mm	20pcs	240pcs	8.00kg	0.035kg
M 14110	10mm	140mm	20pcs	200pcs	9.00kg	0.045kg
M 14111	11mm	151mm	20pcs	200pcs	11.00kg	0.055kg
M 14112	12mm	161mm	20pcs	200pcs	13.00kg	0.060kg
M 14113	13mm	171mm	10pcs	200pcs	16.00kg	0.075kg
M 14114	14mm	182mm	10pcs	160pcs	17.00kg	0.094kg
M 14115	15mm	191mm	10pcs	150pcs	18.00kg	0.107kg
M 14116	16mm	201mm	10pcs	150pcs	20.00kg	0.127kg
M 14117	17mm	210mm	10pcs	150pcs	23.00kg	0.143kg
M 14118	18mm	220mm	10pcs	140pcs	24.00kg	0.168kg
M 14119	19mm	231mm	10pcs	120pcs	24.00kg	0.192kg
★ M 14120	20mm	241mm	10pcs	100pcs	22.00kg	0.210kg
M 14121	21mm	252mm	10pcs	100pcs	25.00kg	0.235kg
M 14122	22mm	261mm	10pcs	100pcs	28.00kg	0.265kg
★ M 14123	23mm	274mm	5pcs	80pcs	26.00kg	0.300kg
M 14124	24mm	286mm	5pcs	80pcs	27.00kg	0.331kg
M 14127	27mm	320mm	5pcs	80pcs	30.00kg	0.475kg
M 14130	30mm	336mm	5pcs	30pcs	19.00kg	0.617kg
M 14132	32mm	362mm	5pcs	30pcs	22.00kg	0.717kg
M 14134	34mm	453mm	5pcs	20pcs	16.00kg	0.850kg
M 14136	36mm	453mm	5pcs	20pcs	22.00kg	1.125kg
★ M 14138	38mm	467mm	5pcs	20pcs	23.00kg	1.075kg
★ M 14140	40mm	480mm	5pcs	10pcs	14.00kg	1.300kg
M 14141	41mm	480mm	5pcs	10pcs	13.00kg	1.300kg
M 14146	46mm	508mm	5pcs	10pcs	18.00kg	1.500kg
M 14150	50mm	508mm	5pcs	10pcs	23.20kg	2.150kg
M 14155	55mm	665mm	2pcs	10pcs	30.00kg	2.700kg
M 14160	60mm	700mm	2pcs	10pcs	34.00kg	3.800kg

- 带★标为非常用规格
- 精抛光双层镀铬处理, 防锈能力强
 - 整体优钢锻造, 坚固耐用
 - △ 本品属于易耗品, 不属于终身保用范围
 - High quality polished and chromed plated, antirust good
 - Whole body drop forged with high quality steel for durable use
 - △ No warranty as consumables

专业级加长双头呆扳手 Double Open End Wrench



货号 Item No	规格 Size	L(总长) length	装盒数 Pc/Box	装箱数 Pc/Carton	毛重 GW/CTN	单支重 NW/PC
M 13102	6 × 7mm	108mm	20pcs	200pcs	6.90kg	0.033kg
M 13103	8 × 10mm	122mm	20pcs	200pcs	8.90kg	0.043kg
M 13104	9 × 11mm	132mm	20pcs	200pcs	11.50kg	0.525kg
M 13105	10 × 12mm	136mm	20pcs	200pcs	12.10kg	0.058kg
M 13107	12 × 14mm	151mm	20pcs	200pcs	16.40kg	0.078kg
M 13108	13 × 15mm	159mm	20pcs	200pcs	18.30kg	0.088kg
M 13109	13 × 16mm	159mm	20pcs	200pcs	18.70kg	0.090kg
M 13110	14 × 17mm	165mm	20pcs	200pcs	22.50kg	0.105kg
M 13111	16 × 18mm	173mm	20pcs	200pcs	25.30kg	0.120kg
M 13112	17 × 19mm	186mm	10pcs	150pcs	22.50kg	0.140kg
M 13113	18 × 21mm	202mm	10pcs	120pcs	21.30kg	0.167kg
M 13115	19 × 22mm	207mm	10pcs	120pcs	23.40kg	0.183kg
M 13117	22 × 24mm	229mm	10pcs	120pcs	31.10kg	0.242kg
M 13119	24 × 27mm	244mm	5pcs	80pcs	27.60kg	0.325kg
M 13120	27 × 30mm	268mm	5pcs	50pcs	22.20kg	0.420kg
M 13121	30 × 32mm	280mm	5pcs	50pcs	26.50kg	0.500kg
M 13124	32 × 36mm	316mm	5pcs	50pcs	32.10kg	0.525kg
M 13125	34 × 36mm	316mm	5pcs	30pcs	19.00kg	0.200kg
M 13126	36 × 41mm	336mm	5pcs	30pcs	24.00kg	0.733kg
M 13127	41 × 46mm	371mm	5pcs	20pcs	21.50kg	1.000kg
★ M 13128	46 × 50mm	400mm	2pcs	10pcs	20.40kg	1.970kg
★ M 13129	50 × 55mm	443mm	2pcs	10pcs	21.80kg	2.000kg

- 带★标为非常用规格
- 精抛光双层镀铬处理, 防锈能力强
 - 整体优钢锻造而成, 坚固耐用
 - △ 本品属于易耗品, 不属于终身保用范围
 - High quality polished and chromed plated, antirust good
 - Whole body drop forged with high quality steel for durable use
 - △ No warranty as consumables

专业级加长两用扳手8、10、14件套 8PCS/10PCS/14PCS Double Box End Wrench Set



货号 Item No	规格 Size	装盒数 Pc/Box	装箱数 Pc/Carton	毛重 GW/CTN	每套重量 Weight Per Set
M 07211	8-22mm × 8pcs	1set	20sets	21.70kg	1.000kg
M 07212	8-27mm × 10pcs	1set	15sets	29.50kg	1.867kg
M 07213	8-24mm × 14pcs	1set	10sets	22.00kg	2.05kg
M 07214	6-32mm × 14pcs	1set	5sets	18.00kg	3.30kg

- Size : 8pcs:8,9,10,12,14,17,19,22mm
10pcs:8,9,10,12,14,17,19,22,24,27mm
14pcs:8,9,10,11,12,13,14,15,16,17,18,21,22,24mm
14pcs:6,8,10,11,12,13,14,17,19,21,24,27,30,32mm
- 包装坚固耐用, 方便携带
 - 整体优钢锻造, 精抛光双层镀铬
 - △ 本品属于易耗品, 不属于终身保用范围
 - Durable Packaging, Easy to carry
 - Drop forged, High quality polished and chromed plated
 - △ No warranty as consumables

专业级加长双头呆扳手8、10件套 8PCS 10PCS Double Open End Wrench Set



货号 Item No	规格 Size	装盒数 Pc/Box	装箱数 Pc/Carton	毛重 GW/CTN	每套重量 Weight Per Set
M07201	6-24mm × 8pcs	1set	16sets	18.10kg	3.125kg
M07202	6-32mm × 10pcs	1set	8sets	16.70kg	2.800kg

- Size : 8pcs:6 × 7, 8 × 10, 10 × 12, 12 × 14, 14 × 17, 17 × 19, 19 × 22, 22 × 24, 24 × 27, 30 × 32mm
- 包装坚固耐用, 方便携带
 - 整体优钢锻造, 精抛光双层镀铬
 - △ 本品属于易耗品, 不属于终身保用范围
 - Durable Packaging, Easy to carry
 - Drop forged, High quality polished and chromed plated
 - △ No warranty as consumables

工业级英制两用扳手 Industrial Grade Combination Wrench SAE

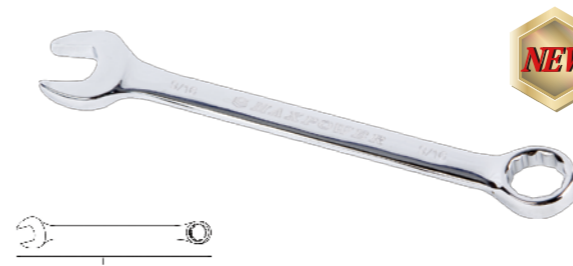

货号 Item No	规格 Size	L(总长) length	装盒数 Pc/Box	装箱数 Pc/Carton	毛重 GW/CTN	单支重 NW/PC
M 14050	1/4"	125mm	10pcs	200pcs	4.50kg	0.022kg
M 14051	5/16"	140mm	10pcs	200pcs	7.50kg	0.033kg
M 14052	3/8"	160mm	10pcs	200pcs	11.00kg	0.050kg
M 14053	7/16"	165mm	10pcs	200pcs	16.50kg	0.077kg
M 14054	1/2"	180mm	10pcs	200pcs	17.50kg	0.090kg
M 14055	9/16"	190mm	5pcs	160pcs	17.00kg	0.100kg
M 14056	5/8"	208mm	5pcs	150pcs	20.00kg	0.125kg
M 14057	11/16"	225mm	5pcs	100pcs	18.50kg	0.170kg
M 14058	3/4"	250mm	5pcs	100pcs	21.50kg	0.200kg
M 14059	13/16"	270mm	5pcs	80pcs	19.50kg	0.230kg
M 14060	7/8"	292mm	5pcs	50pcs	16.50kg	0.300kg
M 14061	15/16"	312mm	5pcs	50pcs	16.50kg	0.303kg
M 14062	1"	323mm	5pcs	50pcs	22.00kg	0.410kg
M 14063	1-1/16"	335mm	5pcs	40pcs	19.50kg	0.460kg
M 14064	1-1/8"	352mm	5pcs	40pcs	24.00kg	0.575kg
M 14065	1-1/4"	375mm	5pcs	30pcs	22.00kg	0.690kg

- 精抛光双层镀铬处理, 防锈能力强
- 整体铬钒钢锻造而成
- △ 本品属于易耗品, 不属于终身保用范围
- High quality polished and chromed plated, antirust good
- Whole body drop forged with Cr-V
- △ No warranty as consumables

工业级英制梅花扳手 Industrial Grade Double Box-end Wrench SAE



货号 Item No	规格 Size	L(总长) length	装盒数 Pc/Box	装箱数 Pc/Carton	毛重 GW/CTN	单支重 NW/PC
M12240	1/4"x5/16"	160mm	10pcs	200pcs	10.00kg	0.045kg
M12241	3/8"x13/32"	190mm	10pcs	200pcs	21.00kg	0.100kg
M12242	7/16"x1/2"	210mm	10pcs	100pcs	14.00kg	0.130kg
M12243	9/16"x19/32"	232mm	5pcs	100pcs	18.00kg	0.170kg
M12244	5/8"x11/16"	232mm	5pcs	100pcs	18.50kg	0.175kg
M12245	3/4"x13/16"	275mm	5pcs	50pcs	15.00kg	0.278kg
M12246	13/16"x7/8"	275mm	5pcs	50pcs	15.00kg	0.278kg
M12247	7/8"x15/16"	320mm	5pcs	50pcs	20.50kg	0.380kg
M12248	15/16"x1"	370mm	5pcs	30pcs	18.00kg	0.560kg
M12249	1"x1-1/16"	370mm	5pcs	30pcs	18.00kg	0.560kg
M12250	1-1/16"x1-1/8"	395mm	5pcs	30pcs	20.00kg	0.615kg
M12251	1-1/8"x1-1/4"	415mm	5pcs	30pcs	21.00kg	0.660kg

- 精抛光双层镀铬处理, 防锈能力强
- 整体铬钒钢锻造而成
- △ 本品属于易耗品, 不属于终身保用范围
- High quality polished and chromed plated, antirust good
- Whole body drop forged with Cr-V
- △ No warranty as consumables

工业级英制双头呆扳手 Industrial Grade Double Open-end Wrench SAE



货号 Item No	规格 Size	L(总长) length	装盒数 Pc/Box	装箱数 Pc/Carton	毛重 GW/CTN	单支重 NW/PC
M 13237	1/4"x5/16"	125mm	10pcs	200pcs	6.00kg	0.025kg
M 13238	3/8"x13/32"	162mm	10pcs	200pcs	12.00kg	0.053kg
M 13239	7/16"x1/2"	180mm	10pcs	200pcs	18.00kg	0.085kg
M 13240	9/16"x19/32"	197mm	10pcs	160pcs	18.50kg	0.110kg
M 13241	5/8"x11/16"	197mm	10pcs	160pcs	20.50kg	0.120kg
M 13242	3/4"x13/16"	240mm	5pcs	80pcs	21.00kg	0.250kg
M 13243	13/16"x7/8"	240mm	5pcs	80pcs	21.00kg	0.250kg
M 13244	7/8"x15/16"	260mm	5pcs	60pcs	20.50kg	0.320kg
M 13245	15/16"x1"	286mm	5pcs	40pcs	18.50kg	0.425kg
M 13246	1"x1-1/16"	286mm	5pcs	40pcs	18.50kg	0.425kg
M 13247	1-1/16"x1-1/8"	296mm	5pcs	30pcs	16.00kg	0.490kg
M 13248	1-1/8"x1-1/4"	310mm	5pcs	30pcs	20.50kg	0.620kg

- 精抛光双层镀铬处理, 防锈能力强
- 整体铬钒钢锻造而成
- △ 本品属于易耗品, 不属于终身保用范围
- High quality polished and chromed plated, antirust good
- Whole body drop forged with Cr-V
- △ No warranty as consumables

英制两用扳手8、10件套 8 pcs/10pcs Combination Wrench Set, SAE



货号 Item No	规格 Size	装盒数 Pc/Box	装箱数 Pc/Carton	毛重 GW/CTN	每套重量 Weight Per Set
M 07216	8pcs	1set	20sets	21.50kg	1.00kg
M 07220	10pcs	1set	10sets	19.30kg	1.78kg

- Size:8PCS:5/16",3/8",7/16",1/2",9/16",5/8",3/4",7/8"
10PCS:5/16",3/8",7/16",1/2",9/16",5/8",3/4",7/8",15/16",1"
- 包装坚固耐用, 方便携带, 采用无毒材料, 符合欧盟标准
 - 整体铬钒钢锻造而成, 精抛光镀铬
 - Durable Packaging, Easy to carry
 - Body drop forged with CRV, High quality polished and chromed plated

双头棘轮梅花快扳 Quick Ratcheting Double Wrench



NEW

Table with 7 columns: Item No, Size, L, Pc/Box, Pc/ Carton, GW/CTN, NW/PC. Lists various sizes of double ratcheting wrenches.

- 优质铬钒钢整体锻造, 硬度高, 韧性好, 喷砂雾面, 表面耐腐防锈
• 双棘轮头设计, 使用快速便捷
• Made of drop forged chrome vanadium steel, durable and high hardness.
Sandblasted matte surface, wear-resistant and rust-proof.
• Double ratchet head design, quick and easy to use.

双头快速棘轮两用扳手 Quick Ratcheting Combination Wrench

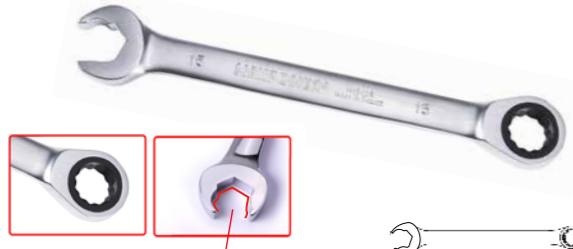

扳手开口端有特殊的角度设计, 便于快速使用

Table with 7 columns: Item No, Size, L, Pc/Box, Pc/ Carton, GW/CTN, NW/PC. Lists various sizes of combination wrenches.

★MADE IN TAIWAN



敲击梅花扳手 Slugging Box Wrench



工业级

Table with 7 columns: Item No, Size, L, D, Pc/Box, Pc/ Carton, GW/CTN, NW/PC. Lists various sizes of slugging box wrenches.

- 带★标为不常用规格
• 采用40CR材质整体锻造, 厚重, 耐用, 表面黑色喷塑
• 款式为欧洲最流行的款式 •通过DIN标准
• It is integrally forged with 40CR material and its surface is sprayed with black plastic, thick and durable
• The style is the most popular in Europe • Through DIN standards

敲击开口扳手 Slugging Open-end Wrench



工业级

Table with 7 columns: Item No, Size, L, D, Pc/Box, Pc/ Carton, GW/CTN, NW/PC. Lists various sizes of slugging open-end wrenches.

- 带★标为不常用规格
• 采用40CR材质整体锻造, 厚重, 耐用, 表面黑色喷塑
• 款式为欧洲最流行的款式 •通过DIN标准
• It is integrally forged with 40CR material and its surface is sprayed with black plastic, thick and durable
• The style is the most popular in Europe • Through DIN standards

工业级球头雾化内六角组套 Ball Point Hex Key set



工业级 S2

工业级球头雾化内六角组套 (加长) 9PCS Long Arm Ball Point Hex Key set 规格 (Size):9pcs(1.5,2,2.5,3,4,5,6,8,10mm)

Table with 7 columns: Item No, Size, Pc/Box, Pc/ Carton, GW/CTN, Weight Per Set. Lists specifications for the 9PCS Long Arm set.

工业级球头雾化内六角组套 (特长) 9PCS Extra Long Arm Ball Point Hex Key set 规格 (Size):9pcs(1.5,2,2.5,3,4,5,6,8,10mm)

Table with 7 columns: Item No, Size, Pc/Box, Pc/ Carton, GW/CTN, Weight Per Set. Lists specifications for the 9PCS Extra Long Arm set.

- 采用 S2 材料制造而成, 整体淬火
• 尾端倒角方便插入槽中, 球形头设计方便在狭小空间使用 • 塑架套装, 方便携带和使用
• Made of S2, Hexagonal ends to fit into nuts.
• Ball end design, easy to be used in narrow area
• mirror polished with double nickel chrome plated, easy to be taking and using

S2球头古铜内六角组套 S2 Ballpoint Brass Hex Key Set



S2 工业级

S2球头古铜内六角组套 (加长) 规格 (Size):9pcs(1.5,2,2.5,3,4,5,6,8,10mm)

Table with 7 columns: Item No, Size, Pc/Box, Pc/ Carton, GW/CTN, Weight Per Set. Lists specifications for the 9PCS Long Arm set.

S2球头古铜内六角组套 (特长) 规格 (Size):9pcs(1.5,2,2.5,3,4,5,6,8,10mm)

Table with 7 columns: Item No, Size, Pc/Box, Pc/ Carton, GW/CTN, Weight Per Set. Lists specifications for the 9PCS Extra Long Arm set.

- 采用 S2 材料制造而成, 古铜表面处理 整体淬火
• 尾端倒角方便插入槽中, 球形头设计方便在狭小空间使用 • 塑架套装, 方便携带和使用
• Made of S2
• Ball end design, easy to be used in narrow area
• mirror polished with double nickel chrome plated, easy to be taking and using

专业级平头内六角组套 Hex Key set



CR-V

球头雾化内六角扳手组套 Hex Key Set With Ball Point,Satin Finish



球头雾化内六角扳手组套 (加长) 9PCS Long Arm Hex Key Set With Ball Point ,Satin Finish 规格 (Size) : 9pcs(1.5,2,2.5,3,4,5,6,8,10mm)

Table with 7 columns: Item No, Size, Pc/Box, Pc/ Carton, GW/CTN, Weight Per Set. Lists specifications for the 9PCS Long Arm set.

球头雾化内六角扳手组套 (特长) 9PCS Extra Long Arm Hex Key Set With Ball Point ,Satin Finish 规格 (Size) : 9pcs(1.5,2,2.5,3,4,5,6,8,10mm)

Table with 7 columns: Item No, Size, Pc/Box, Pc/ Carton, GW/CTN, Weight Per Set. Lists specifications for the 9PCS Extra Long Arm set.

- 采用 S2 材料制造而成, 镜面抛光镀铬, 整体淬火
• 尾端倒角方便插入槽中 • 塑架套装, 方便携带和使用
• Made of S2, mirror polished with double nickel chrome plated, easy to be taking and using

工业级平头电镀内六角组套 Hex Key set, Metric



S2 工业级

工业级平头电镀内六角组套 (特长) 9PCS Extra Long Arm Hex Key Set 规格 (Size) : 9pcs(1.5,2,2.5,3,4,5,6,8,10mm)

Table with 7 columns: Item No, Size, Pc/Box, Pc/ Carton, GW/CTN, Weight Per Set. Lists specifications for the 9PCS Extra Long Arm set.

- 采用 S2 材料制造而成, 镜面抛光镀铬, 整体淬火
• 尾端倒角方便插入槽中 • 塑架套装, 方便携带和使用
• Made of S2, mirror polished with double nickel chrome plated, easy to be taking and using

规格 (Size):9pcs(3,4,5,6,8,10,12,14,17mm)

Table with 7 columns: Item No, Size, Pc/Box, Pc/ Carton, GW/CTN, Weight Per Set. Lists specifications for a 9PCS set.

规格 (Size):10pcs(3,4,5,6,8,10,12,14,17,19mm)

Table with 7 columns: Item No, Size, Pc/Box, Pc/ Carton, GW/CTN, Weight Per Set. Lists specifications for a 10PCS set.

- 特殊热处理, 整体淬火, 尾端倒角方便插入槽中
• 强度高, 不易断裂, 硬度达 HRC50-54 • 工具包装套, 方便使用和携带
• 本品属于易耗品, 不属于终身保用范围
• Fully hardened and tempered. Hexagonal ends to fit into nuts.
• Easy to be taking and using
• No warranty as consumables



INDEX

专业级球头内六角组套
Ball Point Hex Key set

CR-V



专业级球头内六角组套(加长)
9PCS Long Arm Ball Point Hex Key set ,Metric
规格 (Size):9pcs(1.5,2,2.5,3,4,5,6,8,10mm)

货号 Item No	规格 Size	装盒数 Pc/Box	装箱数 Pc/Carton	毛重 GW/CTN	每套重量 Weight Per Set
M 09105	9pcs	6sets	60sets	24.20kg	0.337kg

专业级球头内六角组套(特长)
9PCS Extra Long Arm Ball Point Hex Key set, Metric
规格 (Size):9pcs(1.5,2,2.5,3,4,5,6,8,10mm)

货号 Item No	规格 Size	装盒数 Pc/Box	装箱数 Pc/Carton	毛重 GW/CTN	每套重量 Weight Per Set
M 09101	9pcs	6sets	48sets	23.60kg	0.458kg

- 采用优质Cr-V钢制造而成, 镜面抛光镀铬, 整体淬火
- 塑架套装, 方便携带和使用
- △ 本品属于易耗品, 不属于终身保用范围
- Made of CR-V, mirror polished with double nickel chrome plated, easy to be taking and using
- △ No warranty as consumables

平头电镀内六角组套
Hex Key Set, Metric

CR-V



平头电镀内六角组套(加长)
9PCS Long Arm Hex Key Set
规格 (Size):9pcs(1.5,2,2.5,3,4,5,6,8,10mm)

货号 Item No	规格 Size	装盒数 Pc/Box	装箱数 Pc/Carton	毛重 GW/CTN	每套重量 Weight Per Set
M 09107	9pcs	6sets	60sets	24.00kg	0.340kg

平头电镀内六角组套(特长)
9PCS Extra Long Arm Hex Key Set
规格 (Size):9pcs(1.5,2,2.5,3,4,5,6,8,10mm)

货号 Item No	规格 Size	装盒数 Pc/Box	装箱数 Pc/Carton	毛重 GW/CTN	每套重量 Weight Per Set
M 09103	9pcs	6sets	48sets	23.50kg	0.490kg

- 采用优质 CrV 钢制造而成, 镜面抛光双层镀铬, 塑架套装, 方便携带和使用。
- △ 本品属于易耗品, 不属于终身保用范围
- Made of CRV, mirror polished with double nickel chrome plated, easy to be taking and using
- △ No warranty as consumables

专业级球头内六角组套(英制)
Ball Point Hex Key set, SAE

CR-V



专业级球头内六角组套英制(加长)
9PCS Long Arm Ball Point Hex Key set ,SAE
规格 (Size):1/16",5/64",3/32",1/8",5/32",3/16",1/4",5/16",3/8"

货号 Item No	规格 Size	装盒数 Pc/Box	装箱数 Pc/Carton	毛重 GW/CTN	每套重量 Weight Per Set
M 07937	9pcs	10sets	60sets	22.40kg	0.350kg

专业级球头内六角组套英制(特长)
9PCS Extra Long Arm Ball Point Hex Key set, SAE
规格 (Size):1/16",5/64",3/32",1/8",5/32",3/16",1/4",5/16",3/8"

货号 Item No	规格 Size	装盒数 Pc/Box	装箱数 Pc/Carton	毛重 GW/CTN	每套重量 Weight Per Set
M 07938	9pcs	12sets	48sets	22.70kg	0.438kg

- 采用优质Cr-V钢制造而成, 镜面抛光镀铬, 整体淬火
- 塑架套装, 方便携带和使用
- △ 本品属于易耗品, 不属于终身保用范围
- Made of CR-V, mirror polished with double nickel chrome plated, easy to be taking and using
- △ No warranty as consumables

球头电镀加长内六角组套(英制)
12PCS Long Arm Ball Point Plated Hex Key Set, S.A.E.

CR-V



规格 (Size): 1/16",5/64",3/32",7/64",1/8",9/64",5/32",3/16",7/32",1/4",5/16",3/8"

货号 Item No	规格 Size	装盒数 Pc/Box	装箱数 Pc/Carton	毛重 GW/CTN	每套重量 Weight Per Set
M 09106	12pcs	6sets	36sets	16.78kg	0.39kg

- 采用优质Cr-V钢制造而成, 镜面抛光镀铬, 整体淬火
- 塑架套装, 方便携带和使用
- 球头功能端可倾斜使用
- △ 本品属于易耗品, 不属于终身保用范围
- Made of Cr-V steel, polished, chrome plated and heat-treated.
- Plastic holder for easy portability and use.
- Ball end for easy offset use.
- △ No warranty as consumables

球头雾化特长内六角组套(英制)
12PCS Extra Long Ball Point Hex Key Set, S.A.E.

NEW

S2



规格 (Size):
1/16",5/64",3/32",7/64",1/8",9/64",5/32",3/16",7/32",1/4",5/16",3/8"

货号 Item No	规格 Size	装盒数 Pc/Box	装箱数 Pc/Carton	毛重 GW/CTN	每套重量 Weight Per Set
M 09108	12pcs	6sets	36sets	19.20kg	0.50kg

- 雾面镀铬表面处理, 外形美观, 防锈能力强
- 整体S2合金钢淬火处理
- 球头功能端可倾斜使用
- △ 本品属于易耗品, 不属于终身保用范围
- Matte chrome-plated surface for better appearance and better rust resistance performance.
- Made of S2 alloy steel with heat treatment.
- Ball end for easy offset use.
- △ No warranty as consumables

平头电镀内六角组套(英制)
Hex Key set, SAE

CR-V



平头电镀内六角组套英制(加长)
9PCS Long Arm Hex Key Set
规格 (Size):1/16",5/64",3/32",1/8",5/32",3/16",1/4",5/16",3/8"

货号 Item No	规格 Size	装盒数 Pc/Box	装箱数 Pc/Carton	毛重 GW/CTN	每套重量 Weight Per Set
M 07922	9pcs	10sets	60sets	22.40kg	0.350kg

平头电镀内六角组套英制(特长)
9PCS Extra Long Arm Hex Key Set
规格 (Size):1/16",5/64",3/32",1/8",5/32",3/16",1/4",5/16",3/8"

货号 Item No	规格 Size	装盒数 Pc/Box	装箱数 Pc/Carton	毛重 GW/CTN	每套重量 Weight Per Set
M 07923	9pcs	12sets	48sets	22.70kg	0.438kg

- 采用优质Cr-V钢制造而成, 镜面抛光镀铬, 整体淬火
- 塑架套装, 方便携带和使用
- △ 本品属于易耗品, 不属于终身保用范围
- Made of CR-V, mirror polished with double nickel chrome plated, easy to be taking and using
- △ No warranty as consumables

花型加长扳手套组
Long Arm Torx Key Set

CR-V



规格 (Size):9pcs(T10,T15,T20,T25,T27,T30,T40,T45,T50)

货号 Item No	规格 Size	装盒数 Pc/Box	装箱数 Pc/Carton	毛重 GW/CTN	每套重量 Weight Per Set
M 07955	9pcs	6sets	60sets	23.80kg	0.367kg

- 采用优质 CrV 钢制造而成, 镜面抛光镀铬, 塑架套装, 方便携带和使用。
- △ 本品属于易耗品, 不属于终身保用范围
- Made of CRV, mirror polished with double nickel chrome plated, easy to be taking and using
- △ No warranty as consumables

中孔花型加长扳手套组
9PCS Long Arm Tamper Proof Torx Key Set

CR-V



规格 (Size):
9pcs(T10,T15,T20,T25,T27,T30,T40,T45,T50)

货号 Item No	规格 Size	装盒数 Pc/Box	装箱数 Pc/Carton	毛重 GW/CTN	每套重量 Weight Per Set
M 09715	9pcs	6sets	60sets	23.70kg	0.367kg

- 采用优质 CrV 钢制造而成, 镜面抛光镀铬, 塑架套装, 方便携带和使用。
- △ 本品属于易耗品, 不属于终身保用范围
- Made of CRV, mirror polished with double nickel chrome plated, easy to be taking and using
- △ No warranty as consumables

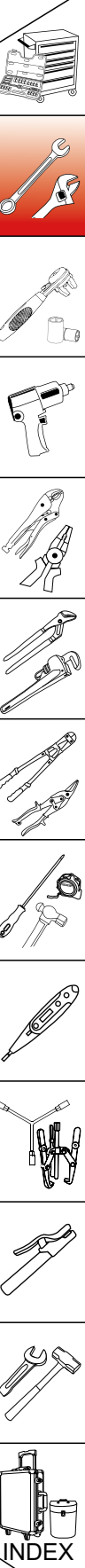

INDEX

T型平头内六角扳手

T-handle hex key

CR-V

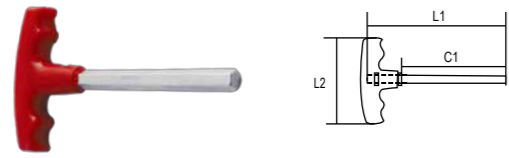

货号 Item No	规格 Size	L1	L2	C1	装盒数 Pc/Box	装箱数 Pc/Carton	毛重 GW/CTN	单支重 NW/PC
M22401	2mm	135mm	73.5mm	96mm	20pcs	400pcs	10.00kg	0.023kg
M22402	2.5mm	135mm	73.5mm	96mm	20pcs	400pcs	10.50kg	0.023kg
M22403	3mm	135mm	73.5mm	96mm	20pcs	400pcs	11.70kg	0.025kg
M22404	4mm	135mm	73.5mm	96mm	20pcs	400pcs	14.30kg	0.033kg
M22405	4.5mm	135mm	73.5mm	96mm	20pcs	400pcs	15.80kg	0.035kg
M22406	5mm	145mm	90mm	97mm	20pcs	400pcs	28.00kg	0.060kg
M22407	5.5mm	145mm	90mm	97mm	20pcs	400pcs	28.40kg	0.043kg
M22408	6mm	145mm	90mm	97mm	20pcs	400pcs	30.10kg	0.071kg
M22409	8mm	145mm	90mm	97mm	20pcs	200pcs	20.80kg	0.095kg
M22410	10mm	145mm	90mm	97mm	20pcs	200pcs	27.40kg	0.130kg

- 采用优质钢制造而成
- 镜面抛光镀铬，注塑手柄舒适快捷。
- △ 本品属于易耗品，不属于终身保用范围
- Made of CRV, mirror polished with double nickel chrome plated
- With comfortable grip
- △ No warranty as consumables

拐杖型球头内六角扳手

T-handle hex key

CR-V



货号 Item No	规格 Size	L1	L2	C1	C2	装盒数 Pc/Box	装箱数 Pc/Carton	毛重 GW/CTN	单支重 NW/PC
M22301	2mm	136.5mm	52.5mm	100mm	15mm	20pcs	400pcs	9.20kg	0.021kg
M22302	2.5mm	136.5mm	52.5mm	100mm	15mm	20pcs	400pcs	10.30kg	0.023kg
M22303	3mm	136.5mm	52.5mm	100mm	15mm	20pcs	400pcs	11.70kg	0.025kg
M22304	4mm	136.5mm	52.5mm	100mm	15mm	20pcs	400pcs	14.80kg	0.033kg
M22305	5mm	196mm	67.5mm	150mm	15mm	20pcs	200pcs	15.90kg	0.070kg
M22306	6mm	196mm	67.5mm	150mm	15mm	20pcs	200pcs	19.50kg	0.090kg
M22308	8mm	260mm	81mm	200mm	15mm	20pcs	100pcs	21.20kg	0.200kg
M22310	10mm	260mm	81mm	200mm	15mm	20pcs	100pcs	28.70kg	0.270kg

- 采用优质钢制造而成 · 镜面抛光镀铬，注塑手柄舒适快捷。
- △ 本品属于易耗品，不属于终身保用范围
- Made of CRV, mirror polished with double nickel chrome plated
- With comfortable grip
- △ No warranty as consumables

T型平头内六角扳手套组

T-handle Ball Point Hex Key

CR-V



规格 (Size): 10pcs(2,2.5,3,4,4.5,5,5.5,6,8,10mm)

货号 Item No	规格 Size	装盒数 Pc/Box	装箱数 Pc/Carton	毛重 GW/CTN	每套重量 Weight Per Set
M07947	10pcs	1set	20sets	18.80kg	0.800kg

- 采用优质 CrV 钢制造而成，镜面抛光镀铬，注塑手柄舒适快捷。金属支架方便取用。
- △ 本品属于易耗品，不属于终身保用范围
- Made of CRV, mirror polished with double nickel chrome plated, easy to be taking and using
- △ No warranty as consumables

工业级球头特长内六角扳手

Extra Long Arm Ball Point Hex Key- Industrial Grade

工业级

S2

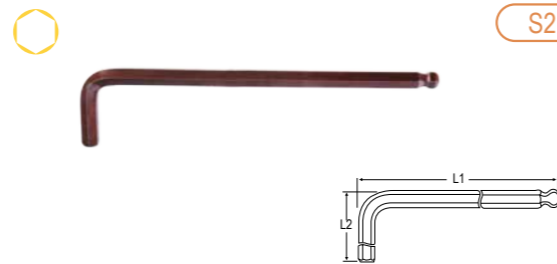

货号 Item No	规格 Size	L1 (mm)	L2 (mm)	装盒数 Pc/Box	装箱数 Pc/Carton	毛重 GW/CTN	单支重 NW/PC
M21009	1.5mm	91.5mm	15.5mm	240pcs	960pcs	1.90kg	0.002kg
M21010	2.0mm	102mm	18mm	240pcs	960pcs	2.90kg	0.003kg
M21011	2.5mm	114.5mm	20.5mm	240pcs	960pcs	4.80kg	0.005kg
M21012	3.0mm	129mm	23mm	240pcs	960pcs	8.60kg	0.009kg
M21013	4.0mm	144mm	29mm	120pcs	480pcs	8.60kg	0.018kg
M21014	5.0mm	165mm	33mm	120pcs	480pcs	15.90kg	0.031kg
M21015	6.0mm	186mm	38mm	60pcs	120pcs	16.60kg	0.050kg
M21017	8.0mm	208mm	44mm	60pcs	120pcs	12.00kg	0.100kg
M21019	10mm	234mm	50mm	60pcs	120pcs	21.60kg	0.180kg

- 采用 S2 材料制造而成
- 特殊热处理，整体淬火，尾端倒角方便插入槽中
- 球形头设计，方便在狭小空间使用
- Made of S2
- Fully hardened and tempered. Hexagonal ends to fit into nuts.
- Ball end design, easy to be used in narrow area.

专业级平头电镀加长内六角扳手

Long Arm Hex Key, Metric

CR-V



货号 Item No	规格 Size	L1 (mm)	L2 (mm)	装盒数 Pc/Box	装箱数 Pc/Carton	毛重 GW/CTN	单支重 NW/PC
M 20100	1.5mm	63.5mm	15.5mm	240pcs	960pcs	1.90kg	0.002kg
M 20101	2.0mm	77mm	18mm	240pcs	960pcs	2.90kg	0.003kg
M 20102	2.5mm	87.5mm	20.5mm	240pcs	960pcs	4.80kg	0.005kg
M 20103	3.0mm	93mm	23mm	240pcs	960pcs	6.70kg	0.007kg
M 20104	4.0mm	104mm	29mm	120pcs	480pcs	7.50kg	0.016kg
M 20105	5.0mm	120mm	33mm	120pcs	480pcs	12.50kg	0.024kg
M 20106	6.0mm	141mm	38mm	60pcs	240pcs	10.70kg	0.039kg
M 20107	7.0mm	147mm	41mm	60pcs	300pcs	18.00kg	0.057kg
M 20108	8.0mm	158mm	44mm	60pcs	240pcs	20.20kg	0.080kg
M 20109	9.0mm	169mm	47mm	40pcs	160pcs	18.00kg	0.106kg
M 20110	10mm	180mm	50mm	60pcs	240pcs	35.10kg	0.140kg
M 20112	12mm	202mm	57mm	30pcs	90pcs	22.00kg	0.230kg
M 20114	14mm	229mm	70mm	8pcs	80pcs	29.40kg	0.360kg
M 20116	16mm	240mm	76mm	6pcs	48pcs	25.00kg	0.500kg
M 20117	17mm	262mm	80mm	6pcs	48pcs	29.30kg	0.590kg
M 20118	18mm	262mm	84mm	6pcs	24pcs	18.00kg	0.708kg
M 20119	19mm	284mm	89mm	6pcs	24pcs	20.30kg	0.820kg
M 20122	22mm	310mm	102mm	6pcs	18pcs	22.20kg	1.190kg
M 20124	24mm	356mm	114mm	2pcs	18pcs	30.40kg	1.690kg
M 20127	27mm	386mm	127mm	2pcs	10pcs	23.50kg	2.290kg
★ M 20128	28mm	390mm	130mm	2pcs	8pcs	20.40kg	2.550kg
★ M 20129	29mm	423mm	141mm	2pcs	8pcs	24.00kg	3.000kg
M 20130	30mm	426mm	142mm	2pcs	6pcs	19.20kg	3.200kg
M 20132	32mm	471mm	157mm	2pcs	6pcs	24.20kg	3.900kg
M 20136	36mm	528mm	176mm	2pcs	4pcs	22.80kg	5.600kg

带★标为不常用规格

- 采用优质 CrV 钢制造而成，特殊热处理，整体淬火，尾端倒角，方便插入槽中，强度高，不易断裂，硬度达 HRC50-54
- △ 本品属于易耗品，不属于终身保用范围
- Made of CRV. Fully hardened and tempered. Hexagonal ends to fit into nuts.
- Strong torsion
- △ This product is a consumable item, excluded from Maxpower's lifetime warranty.

专业级平头电镀特长内六角扳手

Extra Long Arm Hex Key, Metric

CR-V

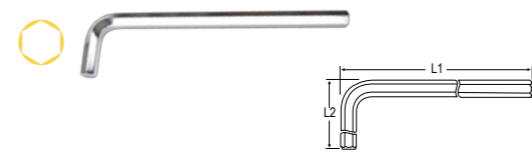

货号 Item No	规格 Size	L1 (mm)	L2 (mm)	装盒数 Pc/Box	装箱数 Pc/Carton	毛重 GW/CTN	单支重 NW/PC
M20201	1.5mm	91.5mm	15.5mm	240pcs	960pcs	1.90kg	0.002kg
M20202	2.0mm	102mm	18mm	240pcs	960pcs	2.90kg	0.003kg
M20203	2.5mm	114.5mm	20.5mm	240pcs	960pcs	4.80kg	0.005kg
M20204	3.0mm	129mm	23mm	240pcs	960pcs	8.60kg	0.009kg
M20205	4.0mm	144mm	29mm	120pcs	480pcs	28.00kg	0.020kg
M20206	5.0mm	165mm	33mm	120pcs	480pcs	25.80kg	0.031kg
M20207	6.0mm	186mm	38mm	60pcs	120pcs	23.50kg	0.049kg
M20209	8.0mm	208mm	44mm	60pcs	120pcs	30.00kg	0.100kg
M20211	10mm	234mm	50mm	60pcs	120pcs	25.60kg	0.160kg
M20213	12mm	262mm	57mm	30pcs	90pcs	26.10kg	0.290kg
M20215	14mm	294mm	70mm	8pcs	80pcs	35.20kg	0.440kg
M20218	17mm	337mm	80mm	6pcs	48pcs	36.50kg	0.760kg
M20220	19mm	364mm	89mm	6pcs	24pcs	24.50kg	1.020kg
M20223	22mm	408mm	102mm	6pcs	18pcs	22.50kg	1.250kg

- 采用优质 6150CrV 钢制造而成，特殊热处理，整体淬火，尾端倒角方便插入槽中，强度高，不易断裂，硬度达 HRC50-54
- △ 本品属于易耗品，不属于终身保用范围
- Made of CRV. Fully hardened and tempered. Hexagonal ends to fit into nuts.
- Strong torsion
- △ No warranty as consumables

专业级球头加长内六角扳手

Long Arm Ball Point Hex Key

CR-V



货号 Item No	规格 Size	L1 (mm)	L2 (mm)	装盒数 Pc/Box	装箱数 Pc/Carton	毛重 GW/CTN	单支重 NW/PC
M 21100	1.5mm	63.5mm	15.5mm	240pcs	960pcs	1.90kg	0.002kg
M 21101	2.0mm	77mm	18mm	240pcs	960pcs	2.90kg	0.003kg
M 21102	2.5mm	87.5mm	20.5mm	240pcs	960pcs	4.80kg	0.005kg
M 21103	3.0mm	93mm	23mm	240pcs	960pcs	7.50kg	0.007kg
M 21104	4.0mm	104mm	29mm	120pcs	480pcs	7.50kg	0.014kg
M 21105	5.0mm	120mm	33mm	120pcs	480pcs	12.60kg	0.023kg
M 21106	6.0mm	141mm	38mm	60pcs	240pcs	10.5kg	0.040kg
M 21108	8.0mm	158mm	44mm	60pcs	240pcs	9.60kg	0.080kg
M 21110	10mm	180mm	50mm	60pcs	240pcs	24.00kg	0.150kg
M 21112	12mm	202mm	57mm	30pcs	90pcs	21.50kg	0.220kg
M 21114	14mm	229mm	70mm	8pcs	80pcs	29.00kg	0.350kg
M 21117	17mm	262mm	80mm	6pcs	48pcs	28.80kg	0.600kg
M 21119	19mm	284mm	89mm	6pcs	24pcs	29.90kg	0.830kg
M 21122	22mm	310mm	102mm	6pcs	18pcs	21.80kg	1.170kg

- 采用优质 CrV 钢制造而成 · 强度超过美标 30% 以上，不打滑，不断裂
- 特殊热处理，整体淬火，尾端倒角方便插入槽中
- 球形头设计，方便在狭小角度使用
- △ 本品属于易耗品，不属于终身保用范围
- Made of CRV. torque can exceed ASME standard 30%
- Fully hardened and tempered. Hexagonal ends to fit into nuts.
- Ball end design, easy to be used in narrow area.
- △ This product is a consumable item, excluded from Maxpower's lifetime warranty.

专业级球头特长内六角扳手

Extra Long Arm Ball Point Hex Key

CR-V

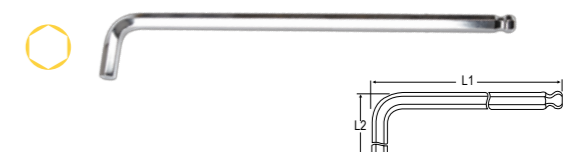

货号 Item No	规格 Size	L1 (mm)	L2 (mm)	装盒数 Pc/Box	装箱数 Pc/Carton	毛重 GW/CTN	单支重 NW/PC
M21201	1.5mm	91.5mm	15.5mm	240pcs	960pcs	1.90kg	0.002kg
M21202	2.0mm	102mm	18mm	240pcs	960pcs	2.90kg	0.003kg
M21203	2.5mm	114.5mm	20.5mm	240pcs	960pcs	5.80kg	0.006kg
M21204	3.0mm	129mm	23mm	240pcs	960pcs	8.60kg	0.009kg
M21205	4.0mm	144mm	29mm	120pcs	480pcs	25.20kg	0.018kg
M21206	5.0mm	165mm	33mm	120pcs	480pcs	15.90kg	0.030kg
M21207	6.0mm	186mm	38mm	60pcs	120pcs	6.00kg	0.050kg
M21209	8.0mm	208mm	44mm	60pcs	120pcs	12.60kg	0.110kg
M21211	10mm	234mm	50mm	60pcs	120pcs	22.00kg	0.180kg
M21213	12mm	262mm	57mm	30pcs	90pcs	27.00kg	0.280kg
M21215	14mm	294mm	70mm	8pcs	80pcs	27.00kg	0.325kg
M21218	17mm	337mm	80mm	6pcs	48pcs	16.00kg	0.313kg
M21220	19mm	364mm	89mm	6pcs	24pcs	25.00kg	1.000kg
M21223	22mm	408mm	102mm	6pcs	18pcs	23.00kg	1.222kg

- 采用优质 CrV 钢制造而成 · 强度超过美标 30% 以上，不打滑，不断裂
- 特殊热处理，整体淬火，尾端倒角方便插入槽中 · 球形头设计，方便在狭小角度使用
- △ 本品属于易耗品，不属于终身保用范围
- Made of CRV. torque can exceed ASME standard 30%
- Fully hardened and tempered. Hexagonal ends to fit into nuts.
- Ball end design, easy to be used in narrow area.
- △ No warranty as consumables

手动套筒、附件类工具

Socket & Accessories

- 套筒..... 56-58
- 套筒塑架组套..... 59-60
- 多头扳手..... 61
- 棘轮扳手..... 61-62
- 附件..... 63-65
- 旋具套筒..... 66-68
- Socket Set..... 56-58
- Socket Wrench Set..... 59-60
- Dog Bone Wrench..... 61
- Ratchet Wrench..... 61-62
- Plastic Shelf Pack..... 63-65
- Rotary Socket..... 66-68

专业级双头尖尾棘轮扳手

Double Tail Ratchet Wrench



产品细节

DETAILS DISPLAY



整体热处理 灵活棘轮拨片 多点式牙口设计

整体热处理, 从而提高 棘轮换向拨片, 调整转动 精确的牙口设计
产品强度, 确保优越性能 方向有效提高工作效率 不打滑更稳定

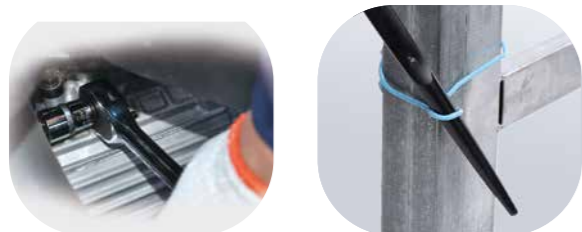

专业力学设计握感舒适

尖尾设计方便工作中作为杠杆使用

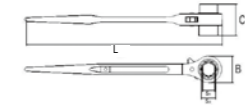

货号 Item No.	规格 Size	L(总长) length	B	C	装盒数 Po/Box	装箱数 Pcs/Carton	毛重 GW/CTN	单支重 NW/PC
★M15504	10-12mm	225mm	37mm	31mm	2pcs	40pcs	9.0kg	0.20kg
M15505	12-14mm	225mm	37mm	31mm	2pcs	40pcs	9.0kg	0.20kg
M15506	14-17mm	265mm	45mm	35mm	2pcs	40pcs	11.4kg	0.26kg
★M15507	16-18mm	310mm	52mm	42mm	2pcs	40pcs	19.4kg	0.46kg
M15508	17-19mm	310mm	52mm	42mm	2pcs	40pcs	19.4kg	0.46kg
★M15509	17-21mm	310mm	52mm	42mm	2pcs	40pcs	19.0kg	0.45kg
★M15511	19-21mm	310mm	52mm	42mm	2pcs	40pcs	19.0kg	0.45kg
M15512	19-22mm	310mm	52mm	42mm	2pcs	40pcs	19.0kg	0.45kg
M15513	19-24mm	365mm	55mm	51mm	2pcs	32pcs	23.4kg	0.70kg
M15514	22-24mm	365mm	55mm	51mm	2pcs	32pcs	23.4kg	0.70kg
★M15515	24-27mm	365mm	55mm	51mm	2pcs	32pcs	23.4kg	0.70kg
★M15516	27-30mm	400mm	62mm	58mm	2pcs	20pcs	19.0kg	0.90kg
M15517	30-32mm	400mm	62mm	58mm	2pcs	20pcs	19.0kg	0.90kg
M15518	32-36mm	445mm	68mm	80mm	2pcs	12pcs	22.6kg	1.80kg
M15519	36-41mm	445mm	68mm	80mm	2pcs	12pcs	22.0kg	1.75kg
★M15520	41-46mm	445mm	68mm	80mm	2pcs	12pcs	22.0kg	1.75kg

带★标为不常用规格

- 采用优质合金钢锻造而成, 方便快捷。
- 强扭扭矩设计, 适用于重型作业
- △本品属精密仪器, 不属于工具终身保用范围
- Body drop-forged with super alloy steel chrome plated
- Strong torque designed, suitable for heavy work
- △ This product is a consumable item, excluded from Maxpower's lifetime warranty.

工具小常识

公制外六角螺栓和套筒扳手对边尺寸对照表

螺栓尺寸	对应扳手或套筒对边尺寸	螺栓尺寸	对应扳手或套筒对边尺寸
M3	5.5mm	M27	41mm
M4	7mm	M30	46mm
M5	8mm	M33	50mm
M6	10mm	M36	55mm
M8	13mm(14mm)	M39	60mm
M10	16mm(17mm)	M42	65mm
M12	18mm(19mm)	M45	70mm
M14	21mm(22mm)	M48	75mm
M16	24mm	M52	80mm
M18	27mm	M56	85mm
M20	30mm	M60	90mm
M22	34mm	M64	95mm
M24	36mm		

注: 括号里的尺寸为GB旧标准尺寸

公制内六角螺栓与内六角扳手尺寸对照表

公制内六角螺栓规格	与内六角扳手相对应尺寸	公制内六角螺栓规格	与内六角扳手相对应尺寸
M3	2.5	M14	12
M4	3	M16	14
M5	4	M18	14
M6	5	M20	17
M8	6	M22	17
M10	8	M24	19
M12	10	M27	19

公制、英制尺寸对照表

公制	英制
6.3mm	1/4"
10mm	3/8"
12.5mm	1/2"
20mm	3/4"
25mm	1"



INDEX

防滑六角套筒 Anti-slip 6pt Socket



· 优质铬钒钢锻造，整支热处理，通过德国 VPA/GS 认证，强度超过美国标准 50%
· Drop forged with CRV, heat treatment, VPA/GS approval, strength will be 50% stronger than ANSI standard

6.3mm 系列六角套筒 (1/4" Dr. 6pt Socket)

Table with 8 columns: Item No, Size, length, d, D, Pcs/Box, Pcs/Carton, GW/CTN, NW/PC. Lists various 6.3mm socket specifications.

10mm 系列六角套筒 (3/8" Dr. 6pt Socket)

Table with 8 columns: Item No, Size, length, d, D, Pcs/Box, Pcs/Carton, GW/CTN, NW/PC. Lists various 10mm socket specifications.

12.5mm 系列六角套筒 (1/2" Dr. 6pt Socket)

Table with 8 columns: Item No, Size, length, d, D, Pcs/Box, Pcs/Carton, GW/CTN, NW/PC. Lists various 12.5mm socket specifications.

注: ★为不常用规格

防滑十二角套筒 Anti-slip 12pt socket



· 优质钢材热锻而成，性能优越，表面双色滚花。
· 通过德国 VPA/GS 认证，强度超过美国标准 50%
· Drop forged with super alloy steel, good performance, polished and satin finished with knurled · VPA/GS approval, strength will be 50% stronger than ANSI standard

12.5mm 系列十二角套筒 (1/2" Dr. 12pt Socket)

Table with 8 columns: Item No, Size, length, d, D, Pcs/Box, Pcs/Carton, GW/CTN, NW/PC. Lists various 12.5mm 12pt socket specifications.

20mm 系列十二角套筒 (3/4" Dr. 12pt Socket)

Table with 8 columns: Item No, Size, length, d, D, Pcs/Box, Pcs/Carton, GW/CTN, NW/PC. Lists various 20mm 12pt socket specifications.

注: ★为不常用规格

(接下页)

(接上页) 25mm 系列十二角套筒 1" Dr. 12pt Socket

Table with 8 columns: Item No, Size, length, d, D, Pcs/Box, Pcs/Carton, GW/CTN, NW/PC. Lists various 25mm 12pt socket specifications.

工业级六角长套筒 6pt Deep Socket

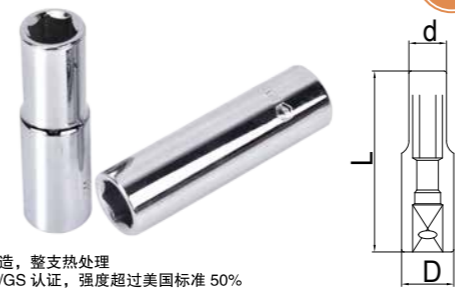

· 优质铬钒钢锻造，整支热处理
· 通过德国 VPA/GS 认证，强度超过美国标准 50%
· Drop forged with CRV, heat treatment
· VPA/GS approval, strength will be 50% stronger than ANSI standard

6.3mm 系列六角长套筒 (1/4" Dr. 6pt deep socket)

Table with 8 columns: Item No, Size, length, d, D, Pcs/Box, Pcs/Carton, GW/CTN, NW/PC. Lists various 6.3mm deep socket specifications.

10mm 系列六角长套筒 (3/8" Dr. 6pt deep socket)

Table with 8 columns: Item No, Size, length, d, D, Pcs/Box, Pcs/Carton, GW/CTN, NW/PC. Lists various 10mm deep socket specifications.

注: ★为不常用规格

(接下页)

(接上列)

12.5mm 系列六角长套筒 (1/2" Dr. 6pt deep socket)

Table with 8 columns: Item No, Size, length, d, D, Pcs/Box, Pcs/Carton, GW/CTN, NW/PC. Lists various 12.5mm deep socket specifications.

工业级十二角长套筒 12pt Deep Socket



· 优质铬钒钢锻造，整支热处理
· 通过德国 VPA/GS 认证，强度超过美国标准 50%
· Drop forged with CRV, heat treatment
· VPA/GS approval, strength will be 50%

12.5mm 系列十二角长套筒 (1/2" Dr. 12pt deep socket)

Table with 8 columns: Item No, Size, length, d, D, Pcs/Box, Pcs/Carton, GW/CTN, NW/PC. Lists various 12.5mm 12pt deep socket specifications.

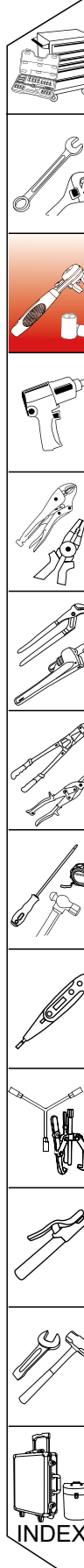
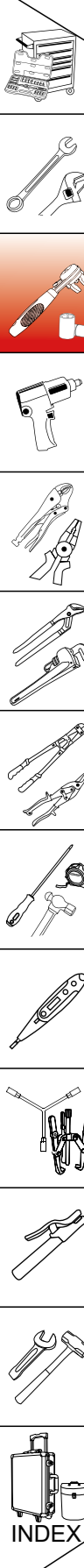

大R角套筒
R angle socket



- 铬钒钢材质
- 薄壁设计
- 圆弧内角设计
- 专业设计，锁定更加强劲
- 减少对螺母边角的损伤和磨损
- 即使是磨损的螺母也可以有效锁定
- Material: CRV steel
- Thinner wall design
- Arc inner angle design
- Professional design, easier to lock
- The product can reduce the damage to corners of the screw
- Even for worn screws, it can effectively lock

花型套筒
E-Torx Socket



10mm 系列花型套筒 (3/8"Dr. E Socket)

货号 Item No	规格 Size	总长 length	d	D	装盒数 Pc/Box	装箱数 Pc/Carton	毛重 GW/CTN	单支重 NW/PC
M 43704	E6	28mm	9.6mm	16.8mm	30pcs	600pcs	14.50kg	0.020kg
M 43705	E7	28mm	10.8mm	16.8mm	30pcs	600pcs	16.40kg	0.025kg
M 43706	E8	28mm	12.0mm	16.8mm	30pcs	600pcs	17.00kg	0.027kg
M 43708	E10	28mm	14.5mm	16.8mm	30pcs	600pcs	18.00kg	0.028kg
M 43709	E11	28mm	15.5mm	16.8mm	30pcs	600pcs	18.94kg	0.030kg
M 43710	E12	28mm	15.5mm	16.8mm	30pcs	600pcs	18.00kg	0.029kg
M 43712	E14	28mm	16.0mm	17.8mm	20pcs	400pcs	13.80kg	0.031kg
M 43714	E16	28mm	17.7mm	15.5mm	20pcs	400pcs	12.30kg	0.030kg
M 43716	E18	28mm	21.7mm	19.0mm	12pcs	240pcs	14.90kg	0.060kg
M 43718	E20	30mm	23.7mm	21.0mm	12pcs	240pcs	16.60kg	0.070kg

12.5mm 系列花型套筒 (1/2"Dr. E Socket)

货号 Item No	规格 Size	总长 length	d	D	装盒数 Pc/Box	装箱数 Pc/Carton	毛重 GW/CTN	单支重 NW/PC
M 44711	E8	38mm	13.8mm	21.8mm	20pcs	400pcs	21.50kg	0.050kg
M 44713	E10	38mm	15.3mm	21.8mm	20pcs	400pcs	22.70kg	0.054kg
M 44714	E11	38mm	16.5mm	21.8mm	20pcs	400pcs	23.60kg	0.059kg
M 44715	E12	38mm	17.8mm	21.8mm	20pcs	400pcs	25.00kg	0.059kg
M 44717	E14	38mm	20.3mm	21.8mm	20pcs	400pcs	27.60kg	0.066kg
M 44719	E16	38mm	20.5mm	21.8mm	20pcs	400pcs	26.60kg	0.063kg
M 44721	E18	38mm	23.7mm	22.0mm	20pcs	320pcs	26.00kg	0.080kg
M 44723	E20	38mm	23.7mm	22.0mm	20pcs	320pcs	25.00kg	0.075kg
M 44725	E22	38mm	25.7mm	23.0mm	16pcs	160pcs	14.00kg	0.084kg
M 44727	E24	38mm	27.7mm	24.5mm	16pcs	160pcs	17.44kg	0.104kg

英制套筒
SAE Hex Sockets



· 优质铬钒钢锻造，整支热处理，通过德国 VPA/GS 认证，强度超过美国标准 50%
· Drop forged with CRV, heat treatment, VPA/GS approval, strength will be 50% stronger than ANSI standard

1/4"系列英制六角套筒 (1/4" Dr. 6pt Socket)

货号 Item No	规格 Size	总长 length	d	D	装盒数 Pc/Box	装箱数 Pc/Carton	毛重 GW/CTN	单支重 NW/PC
M 42200	5/32"	25mm	6.7mm	11.7mm	63pcs	1260pcs	15.00kg	0.010kg
M 42202	3/16"	25mm	8mm	11.7mm	63pcs	1260pcs	14.00kg	0.010kg
M 42203	7/32"	25mm	8.6mm	11.7mm	63pcs	1260pcs	14.00kg	0.010kg
M 42204	1/4"	25mm	9.4mm	11.7mm	63pcs	1260pcs	15.50kg	0.011kg
M 42205	9/32"	25mm	10.8mm	11.7mm	63pcs	1260pcs	16.50kg	0.014kg
M 42206	5/16"	25mm	10.8mm	11.7mm	63pcs	1260pcs	16.80kg	0.012kg
M 42207	11/32"	25mm	12.2mm	13.6mm	48pcs	960pcs	19.50kg	0.019kg
M 42208	3/8"	25mm	12.7mm	13.6mm	48pcs	960pcs	17.00kg	0.015kg
M 42210	7/16"	25mm	13.5mm	15.7mm	35pcs	700pcs	17.00kg	0.022kg
M 42212	1/2"	25mm	16mm	17.7mm	30pcs	600pcs	16.00kg	0.024kg

3/8"系列英制六角套筒 (3/8" Dr. 6pt Socket)

货号 Item No	规格 Size	总长 length	d	D	装盒数 Pc/Box	装箱数 Pc/Carton	毛重 GW/CTN	单支重 NW/PC
M 43204	1/4"	28mm	9.4mm	16.9mm	30pcs	600pcs	13.40kg	0.020kg
M 43206	5/16"	28mm	12mm	16.9mm	30pcs	600pcs	15.50kg	0.022kg
M 43208	3/8"	28mm	14.5mm	16.9mm	30pcs	600pcs	16.80kg	0.025kg
M 43210	7/16"	28mm	15.8mm	16.9mm	30pcs	600pcs	17.40kg	0.025kg
M 43212	1/2"	28mm	17.7mm	17.0mm	30pcs	600pcs	19.80kg	0.030kg
M 43214	9/16"	28mm	19.7mm	18.0mm	20pcs	400pcs	14.50kg	0.031kg
M 43216	5/8"	28mm	21.9mm	19.0mm	20pcs	400pcs	17.10kg	0.035kg
M 43217	11/16"	30mm	23.7mm	21.0mm	12pcs	240pcs	13.10kg	0.048kg
M 43220	3/4"	30mm	25.9mm	22.0mm	12pcs	240pcs	15.50kg	0.052kg
M 43223	13/16"	32mm	27.7mm	26.0mm	12pcs	240pcs	20.30kg	0.077kg
M 43224	7/8"	32mm	29.7mm	26.0mm	9pcs	180pcs	16.20kg	0.082kg

1/2"系列英制六角套筒 (1/2" Dr. 6pt Socket)

货号 Item No	规格 Size	总长 length	d	D	装盒数 Pc/Box	装箱数 Pc/Carton	毛重 GW/CTN	单支重 NW/PC
M 44206	5/16"	38mm	13.8	21.9	20pcs	400pcs	21kg	0.05kg
M 44208	3/8"	38mm	15.3	21.9	20pcs	400pcs	20.3kg	0.047kg
M 44209	7/16"	38mm	16.5	21.9	20pcs	400pcs	21.6kg	0.051kg
M 44211	1/2"	38mm	19	21.9	20pcs	400pcs	22.9kg	0.051kg
M 44212	9/16"	38mm	20.3	21.9	20pcs	400pcs	23.2kg	0.056kg
M 44214	5/8"	38mm	21.9	20.5	20pcs	400pcs	21.4kg	0.05kg
M 44215	11/16"	38mm	23.7	22	20pcs	400pcs	27.3kg	0.064kg
M 44217	3/4"	38mm	25.9	23	20pcs	320pcs	21.6kg	0.064kg
M 44219	13/16"	38mm	27.7	24.5	20pcs	320pcs	26.4kg	0.078kg
M 44220	7/8"	38mm	29.6	26	16pcs	160pcs	15.3kg	0.092kg
M 44222	15/16"	38mm	31.7	26	16pcs	160pcs	16.3kg	0.106kg
M 44224	1"	41mm	35.6	28	16pcs	160pcs	26.1kg	0.123kg
M 44225	1-1/16"	43mm	35.6	30	16pcs	160pcs	26.7kg	0.162kg
M 44227	1-1/8"	44mm	37.9	32	12pcs	120pcs	21.7kg	0.171kg
M 44229	1-1/4"	44mm	41.9	34	9pcs	90pcs	19.4kg	0.205kg

10件公制套筒组套
10PCS Socket Wrench Set



- 6.3mm (1/4"Dr.)
- 10 件公制套筒 5,6,7,8,9,10,11,12,13,14mm
- 10pcs Metric Sockets 5,6,7,8,9,10,11,12,13,14mm

货号 Item No	规格 Size	产品编号 Product No	装盒数 Pc/Box	装箱数 Pc/Carton	毛重 GW/CTN
M 07159	10pcs	TK-078	10sets	40sets	10.5kg

- 10mm (3/8"Dr.)
- 10 件公制套筒 10,11,12,13,14,15,16,17,19,22mm
- 10pcs Metric Sockets 10,11,12,13,14,15,16,17,19,22mm

货号 Item No	规格 Size	产品编号 Product No	装盒数 Pc/Box	装箱数 Pc/Carton	毛重 GW/CTN
M 07099	10pcs	TK-082	10sets	30sets	18.00kg

- 12.5mm (1/2"Dr.)
- 10 件公制套筒 10,11,12,13,14,15,17,19,22,24mm
- 10pcs Metric Sockets 10,11,12,13,14,15,17,19,22,24mm

货号 Item No	规格 Size	产品编号 Product No	装盒数 Pc/Box	装箱数 Pc/Carton	毛重 GW/CTN
M 07054	10pcs	TK-080	10sets	20sets	16.00kg

△ 塑料架不属于终身保用范围，所配置的单支产品请参照单支工具的保用条款
△ The tool holder is not covered by our lifetime warranty. For single product configured in the box, please refer to the single tool warranty terms.

11件公制套筒组套
11PCS Socket Wrench Set



- 6.3mm (1/4"Dr.)
- 10 件公制套筒 5,6,7,8,9,10,11,12,13,14mm
- 1 件20型 快脱棘轮扳手
- 10pcs Metric Sockets 5,6,7,8,9,10,11,12,13,14mm
- 1pc Accessory Quick Release Ratchet Handle

货号 Item No	规格 Size	产品编号 Product No	装盒数 Pc/Box	装箱数 Pc/Carton	毛重 GW/CTN
M 07160	11pcs	TK-049	1set	24sets	10.7kg

- 10mm (3/8"Dr.)
- 10 件公制套筒 10,11,12,13,14,15,16,17,19,22mm
- 1 件20型 快脱棘轮扳手
- 10pcs Metric Sockets 10,11,12,13,14,15,16,17,19,22mm
- 1pc Accessory Quick Release Ratchet Handle

货号 Item No	规格 Size	产品编号 Product No	装盒数 Pc/Box	装箱数 Pc/Carton	毛重 GW/CTN
M 07100	11pcs	TK-050	1set	24sets	20.50kg

- 12.5mm (1/2"Dr.)
- 10 件公制套筒 10,11,12,13,14,15,17,19,22,24mm
- 1 件20型 快脱棘轮扳手
- 10pcs Metric Sockets 10,11,12,13,14,15,17,19,22,24mm
- 1pc Accessory Quick Release Ratchet Handle

货号 Item No	规格 Size	产品编号 Product No	装盒数 Pc/Box	装箱数 Pc/Carton	毛重 GW/CTN
M 07051	11pcs	TK-051	1set	12sets	16.50kg

△ 塑料架不属于终身保用范围，所配置的单支产品请参照单支工具的保用条款
△ The tool holder is not covered by our lifetime warranty. For single product configured in the box, please refer to the single tool warranty terms.

14 件 6.3mm 系列公制套筒组套
14PCS 1/4"Dr. Socket Wrench Set



- 13 件公制套筒 4,4.5,5,5.5,6,7,8,9,10,11,12,13,14mm
- 1 件20型 快脱棘轮扳手
- 13pcs Metric Sockets 4,4.5,5,5.5,6,7,8,9,10,11,12,13,14mm
- 1pc Accessory Quick Release Ratchet Handle

货号 Item No	规格 Size	产品编号 Product No	装盒数 Pc/Box	装箱数 Pc/Carton	毛重 GW/CTN
M 07163	14pcs	TK-052	1set	24sets	14.00kg

△ 塑料架不属于终身保用范围，所配置的单支产品请参照单支工具的保用条款
△ The tool holder is not covered by our lifetime warranty. For single product configured in the box, please refer to the single tool warranty terms.

21件公英制套筒组套
21PCS Socket Wrench Set



- 20 件套筒 10,11,12,13,14,15,16,17,19,22mm
- 5/16", 3/8", 7/16", 1/2", 9/16", 5/8", 11/16", 3/4", 13/16", 7/8"
- 1 件20型 快脱棘轮扳手
- 20pcs Sockets 10,11,12,13,14,15,16,17,19,22mm
- 5/16", 3/8", 7/16", 1/2", 9/16", 5/8", 11/16", 3/4", 13/16", 7/8"
- 1pc Accessory Quick Release Ratchet Handle

货号 Item No	规格 Size	产品编号 Product No	装盒数 Pc/Box	装箱数 Pc/Carton	毛重 GW/CTN
M 07101	21pcs	TK-084	1set	12sets	16.50kg

- 12.5mm (1/2"Dr.)
- 20 件套筒 10,11,12,13,14,15,17,19,22,24mm
- 3/8", 7/16", 1/2", 9/16", 5/8", 11/16", 3/4", 13/16", 7/8", 15/16"
- 1 件20型 快脱棘轮扳手
- 20p Sockets 10,11,12,13,14,15,17,19,22,24mm
- 3/8", 7/16", 1/2", 9/16", 5/8", 11/16", 3/4", 13/16", 7/8", 15/16"
- 1pc Accessory Quick Release Ratchet Handle

货号 Item No	规格 Size	产品编号 Product No	装盒数 Pc/Box	装箱数 Pc/Carton	毛重 GW/CTN
M 07061	21pcs	TK-085	1set	12sets	26.00kg

△ 塑料架不属于终身保用范围，所配置的单支产品请参照单支工具的保用条款
△ The tool holder is not covered by our lifetime warranty. For single product configured in the box, please refer to the single tool warranty terms.



25件6.3mm系列套筒组套
25PCS 1/4"Dr. Socket Wrench Set

CR-V



- 12件公制套筒 4,4.5,5,5.5,6,7,8,9,10,11,12,13mm
- 12件25mm长旋具套筒十字PH1,PH2 一字3,4,5,6,7mm 六角3,4,5,6,8mm
- 1件20型快脱棘轮扳手
- 12pcs Metric Sockets 4,4.5,5,5.5,6,7,8,9,10,11,12,13mm
- 12pcs 1/4"Shank Bits Philips PH1,PH2 Slotted 3,4,5,6,7mm Hex 3,4,5,6,8mm
- 1pc Accessory Quick Release Ratchet Handle

货号 Item No	规格 Size	产品编号 Product No	装盒数 Pc/Box	装箱数 Pc/Carton	毛重 GW/CTN
M 07171	25pcs	TK-054	1set	24sets	17.00kg

△塑料架不属于终身保用范围,所配置的单支产品请参照单支工具的保用条款
△The tool holder is not covered by our lifetime warranty. For single product configured in the box, please refer to the single tool warranty terms.

10件6.3mm系列公制套筒组套
10PCS 1/4"Dr. Socket Wrench Set



- 10件公制套筒 4,5,6,7,8,9,10,11,12,13mm
- 10 pcs Metric Sockets 4,5,6,7,8,9,10,11,12,13mm

货号 Item No	规格 Size	装盒数 Pc/Box	装箱数 Pc/Carton	毛重 GW/CTN
M 07156	10pcs	4sets	24sets	5.70kg

△塑料架不属于终身保用范围,所配置的单支产品请参照单支工具的保用条款
△The tool holder is not covered by our lifetime warranty. For single product configured in the box, please refer to the single tool warranty terms.

7件10mm系列公制批头套筒组套
7PCS 3/8" Dr. Bit Socket Wrench Set



- 7件公制批头套筒 3,4,5,6,7,8,10 mm
- 7 pcs Metric Sockets 3,4,5,6,7,8,10 mm

货号 Item No	规格 Size	装盒数 Pc/Box	装箱数 Pc/Carton	毛重 GW/CTN
M 07115	7pcs	4sets	24sets	8.82kg

△塑料架不属于终身保用范围,所配置的单支产品请参照单支工具的保用条款
△The tool holder is not covered by our lifetime warranty. For single product configured in the box, please refer to the single tool warranty terms.

9件10mm系列公制套筒组套
9PCS 3/8" Dr.Socket Wrench Set



- 9件公制套筒 10,13,14,16,17,18,19,21,22 mm
- 9 pcs Metric Sockets 10,13,14,16,17,18,19,21,22 mm

货号 Item No	规格 Size	装盒数 Pc/Box	装箱数 Pc/Carton	毛重 GW/CTN
M 07116	9pcs	4sets	24sets	14.4kg

△塑料架不属于终身保用范围,所配置的单支产品请参照单支工具的保用条款
△The tool holder is not covered by our lifetime warranty. For single product configured in the box, please refer to the single tool warranty terms.

9件10mm系列公制长套筒组套
9PCS 3/8" Dr. Deep Socket Wrench Set



- 9件公制套筒 10,12,13,14,15,16,17,18,19 mm
- 9pcs Metric Deep Sockets 10,12,13,14,15,16,17,18,19 mm

货号 Item No	规格 Size	装盒数 Pc/Box	装箱数 Pc/Carton	毛重 GW/CTN
M 07117	9pcs	4sets	24sets	27.2kg

△塑料架不属于终身保用范围,所配置的单支产品请参照单支工具的保用条款
△The tool holder is not covered by our lifetime warranty. For single product configured in the box, please refer to the single tool warranty terms.

10件12.5mm系列公制套筒组套
10PCS 1/2" Dr. Socket Wrench Set



- 10件公制套筒 8,10,11,12,13,14,17,19,22,24 mm
- 10 pcs Metric Sockets 8,10,11,12,13,14,17,19,22,24 mm

货号 Item No	规格 Size	装盒数 Pc/Box	装箱数 Pc/Carton	毛重 GW/CTN
M 07063	10pcs	4sets	24sets	20.3kg

△塑料架不属于终身保用范围,所配置的单支产品请参照单支工具的保用条款
△The tool holder is not covered by our lifetime warranty. For single product configured in the box, please refer to the single tool warranty terms.

专业级八合一多头扳手
Dog Bone Wrench

专利

CR-V



货号 Item No	规格 Size	L(总长) length	装盒数 Pc/Box	装箱数 Pc/Carton	毛重 GW/CTN	单支重 NW/PC
M 11741	12 x 13 x 14 x 15- 16 x 17 x 18 x 19mm	252.5mm	6pcs	36pcs	22.50kg	0.540kg

- 专利产品 ZL200920218757.2
- 铬钒钢整体锻造, 整支热处理, 精抛光双层镀铬处理
- 带强磁装置, 便于安全放置
- Patent products ZL200920218757.2
- Made of CRV, mirror polished with double nickel chrome plated
- With magnet on the handle, easy to be used



多功能可调套筒扳手
Multi Function Ratcheting Wrench

专利



货号 Item No	规格 Size	L(总长) length	W	开口量 Opening Capacity	装盒数 Pc/Box	装箱数 Pc/Carton	毛重 GW/CTN	单支重 NW/PC
M 11730	10mm(3/8")	200mm	50mm	6.35-22.2mm	4pcs	24pcs	12.00kg	0.450kg

- 专利产品 ZL200520083426.4
- 具有活扳手、套筒、棘轮扳手功能
- Patent products ZL200520083426.4
- With the function of adjustable wrench, socket, ratchet wrench



快脱型棘轮扳手
Ratchet Wrench

NEW

CR-V



货号 Item No	规格 Size	L(总长) length	装盒数 Pc/Box	装箱数 Pc/Carton	毛重 GW/CTN	单支重 NW/PC
M 48251	6.3mm	150mm	6pcs	72pcs	11.08kg	0.14kg
M 48252	10mm	200mm	6pcs	48pcs	15.88kg	0.31kg
M 48253	12.5mm	250mm	4pcs	40pcs	23.80kg	0.57kg

- 优质CRV钢整体锻造
- 棘轮头采用72齿设计
- Made of drop forged high quality Cr-V steel
- 72 teeth design

工业级棘轮扳手
Ratchet Handle

CR-V



货号 Item No	规格 Size	L(总长) length	装盒数 Pc/Box	装箱数 Pc/Carton	毛重 GW/CTN	单支重 NW/PC
M48272	6.3mm(1/4")	150mm	6pcs	72pcs	14.50kg	0.130kg
M48273	10mm(3/8")	200mm	6pcs	48pcs	15.50kg	0.300kg
M48274	12.5mm(1/2")	250mm	4pcs	40pcs	20.00kg	0.530kg

- 采用优质CRV钢材整体锻造, 连续炉整体淬火, 保证了手柄的超高硬度
- 72齿设计, 通过德国VPA-GS认证
- 内部弹簧采用优质的柔软65Mn材质, 保证手柄回旋转松
- High quality CRV drop forged steel, heat-treated, which guarantee the good hardness of the body
- 72 teeth design, with VPA/GS certificate
- The internal spring made of high quality soft 65Mn material which guarantee the smooth rotation of the handle

梨头弯柄棘轮扳手
Ratchet Wrench



工业级
CR-V

货号 Item No	规格 Size	L(总长) length	装箱数 Pc/Box	装箱数 Pc/ Carton	毛重 GW/CTN	单支重 NW/PC
M 48266	6.3mm(1/4")	150mm	6pcs	72pcs	9.80kg	0.130kg
M 48267	10mm(3/8")	200mm	6pcs	48pcs	15.50kg	0.300kg
M 48268	12.5mm(1/2")	250mm	5pcs	40pcs	23.60kg	0.560kg

- 采用优质CR-V钢材整体锻造,连续炉整体淬火,保证了手柄的超高硬度
- 72齿设计
- 内部压簧采用优质的柔软65Mn材质,保证手柄回旋轻松
- High quality CRV drop forged steel, heat-treated, which guarantee the good hardness of the body
- 72 teeth design
- The internal spring made of high quality soft 65Mn material which guarantee the smooth rotation of the handle

强力型梨头棘轮组合扳手
Ratchet Wrench



a.

货号 Item No	规格 Size	总长 length	装箱数 Pc/ Carton	单支重 NW/PC
M 48167	20mm(3/4")	625mm	8pcs	2.60kg

b.

货号 Item No	规格 Size	总长 length	装箱数 Pc/ Carton	单支重 NW/PC
M 48168	25mm(1")	685mm	4pcs	4.055kg

伸缩双向棘轮扳手
Extendable Quick Release Ratchet



CR-V

货号 Item No	规格 Size	L总长(缩进伸开) length(retract/spread)	装箱数 Pc/Box	装箱数 Pc/ Carton	毛重 GW/CTN	单支重 NW/PC
M 48327	12.5mm(1/2")	x400mm	270/410mm	2pcs	20pcs	19.80kg 0.92kg

- 驱动头采用CR-V铬钒钢精工锻造,镜面抛光处理
- 具有快速脱落功能,可单手操作转向功能
- 6档调节,每个档位30mm,长度从270-410mm,加长扭力
- 72齿棘轮设计,只需5°旋转
- Drive head is made of CRV drop forged steel, mirror finish
- Quick release function, single hand can change direction
- 6 gears, each gear 30MM, length is from 270mm-410mm, extended torque
- 72 teeth design, only need 5 degree rotation

棘轮头
Ratchet Head



货号 Item No	规格 Size	L(总长) length	装箱数 Pc/ Carton	毛重 GW/CTN	单支重 NW/PC
M 48172	20mm x155mm	155mm	16pcs	22.30kg	1.350kg
M 48176	25mm x200mm	200mm	12pcs	25.00kg	1.975kg



加力杆
Adding Force

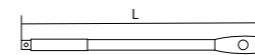

货号 Item No	规格 Size	L(总长) length	装箱数 Pc/ Carton	毛重 GW/CTN	单支重 NW/PC
M 48184	20mm(3/4")x500mm(20")	500mm	12pcs	17.00kg	1.740kg

弓形快速摇柄
Speed Bar

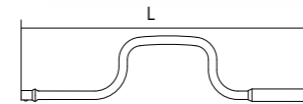

货号 Item No	规格 Size	L(总长) length	装箱数 Pc/ Carton	毛重 GW/CTN	单支重 NW/PC
M 47313	12.5mm(1/2")	400mm	20pcs	10.60kg	0.500kg

软接杆
Flexible Extension Bar

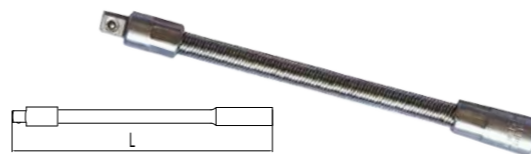

货号 Item No	规格 Size	L(总长) length	装箱数 Pc/ Carton	毛重 GW/CTN	单支重 NW/PC
M 47129	6.3mm(1/4")系列150mm(6")	150mm	300pcs	19.00kg	0.056kg

- 可交换不同角度,适合在狭窄空间操作
- Can change difference angle

转向手柄
Flex Handle



工业级
CR-V

货号 Item No	规格 Size	L(总长) length	装箱数 Pc/Box	装箱数 Pc/ Carton	毛重 GW/CTN	单支重 NW/PC
M 47222	6.3mm x 150mm(1/4" x 6")	150mm	8pcs	96pcs	13.00kg	0.130kg
M 47226	10mm x 200mm(3/8" x 8")	200mm	8pcs	64pcs	18.50kg	0.270kg
M 47232	12.5mm x 250mm(1/2" x 10")	271.5mm	6pcs	36pcs	19.00kg	0.490kg
M 47233	12.5mm x 375mm(1/2" x 15")	386.5mm	6pcs	24pcs	17.30kg	0.680kg
M 47234	12.5mm x 450mm(1/2" x 18")	466.5mm	6pcs	24pcs	25.00kg	0.970kg
M 47235	12.5mm x 600mm(1/2" x 24")	616.5mm	6pcs	18pcs	21.00kg	1.140kg
M 47247	20mm x 475mm(3/4" x 19")	470mm	2pcs	16pcs	31.00kg	1.800kg

- 超过棘轮扳手 50% 以上扭矩,操作更省力
- △ 本品属于易耗品,不属于终身保用范围
- Torque can exceed ratchet wrench more than 50%, easy to use
- △ No warranty as consumables

T型滑行头手柄
Sliding T-bar



CR-V

货号 Item No	规格 Size	L(总长) length	装箱数 Pc/ Carton	毛重 GW/CTN	单支重 NW/PC
M 47113	6.3mm(1/4")	114mm	240pcs	11.00kg	0.040kg
M 47114	10mm(3/8")	165mm	120pcs	18.30kg	0.132kg
M 47115	12.5mm(1/2")	250mm	48pcs	17.10kg	0.336kg

b.



此款D头可拖出

货号 Item No	规格 Size	L(总长) length	装箱数 Pc/ Carton	毛重 GW/CTN	单支重 NW/PC
M 47116	20mm(3/4")	480mm	16pcs	23.30kg	1.40kg
M 47117	25mm(1")	550mm	10pcs	29.20kg	2.71kg

- 可超过棘轮扳手强度 30%,使用寿命更长
- Strength will be 30% stronger than ratchet wrench

弯柄 镀铬

L-handle



货号 Item No	规格 Size	L(总长) length	A	装盒数 Pc/Box	装箱数 Pc/Carton	毛重 GW/CTN	单支重 NW/PC
M47173	12.5mm(1/2")×250mm(10')	248mm	60mm	8pcs	48pcs	20.90kg	0.422kg
M47174	20mm(3/4")×330mm(13')	330mm	100mm	2pcs	20pcs	30.00kg	1.430kg
M47175	20mm(3/4")×450mm(18')	450mm	100mm	2pcs	10pcs	20.00kg	1.900kg

- 扭矩比棘轮扳手提高 50% 以上, 使用寿命更长
- Torque exceed 50% more than ratchet wrench

球头接杆

Extension Bar



货号 Item No	规格 Size	L(总长) length	装盒数 Pc/Box	装箱数 Pc/Carton	毛重 GW/CTN	单支重 NW/PC
M47136	6.3mm(1/4")系列 50mm(2')	50mm	36pcs	720pcs	18.30kg	0.025kg
M47137	6.3mm(1/4")系列 100mm(4')	100mm	36pcs	360pcs	17.10kg	0.046kg

货号 Item No	规格 Size	L(总长) length	装盒数 Pc/Box	装箱数 Pc/Carton	毛重 GW/CTN	单支重 NW/PC
M47143	10mm(3/8")系列 150mm(6')	150mm	12pcs	120pcs	18.00kg	0.147kg
M47144	10mm(3/8")系列 250mm(10')	250mm	10pcs	80pcs	24.30kg	0.300kg

货号 Item No	规格 Size	L(总长) length	装盒数 Pc/Box	装箱数 Pc/Carton	毛重 GW/CTN	单支重 NW/PC
M47150	12.5mm(1/2")系列 75mm(3')	75mm	16pcs	96pcs	12.30kg	0.123kg
M47151	12.5mm(1/2")系列 125mm(5')	125mm	6pcs	48pcs	10.00kg	0.197kg
M47152	12.5mm(1/2")系列 250mm(10')	250mm	6pcs	48pcs	19.00kg	0.385kg

- 适用于狭窄空间, 深度范围内操作
- 强度高, 不断裂, 不变形
- Used in narrow and deep area
- Strong strength, no defoemand rupture

接杆

Extension Bar



货号 Item No	规格 Size	L(总长) length	装盒数 Pc/Box	装箱数 Pc/Carton	毛重 GW/CTN	单支重 NW/PC
M47132	6.3mm(1/4")系列 50mm(2')	50mm	36pcs	720pcs	18.00kg	0.025kg
M47133	6.3mm(1/4")系列 75mm(3')	75mm	27pcs	540pcs	19.30kg	0.034kg
M47134	6.3mm(1/4")系列 100mm(4')	100mm	20pcs	400pcs	19.00kg	0.046kg
M47135	6.3mm(1/4")系列 150mm(6')	150mm	15pcs	300pcs	20.50kg	0.065kg

货号 Item No	规格 Size	L(总长) length	装盒数 Pc/Box	装箱数 Pc/Carton	毛重 GW/CTN	单支重 NW/PC
M47140	10mm(3/8")系列 75mm(3')	75mm	12pcs	240pcs	18.10kg	0.069kg
M47141	10mm(3/8")系列 150mm(6')	150mm	12pcs	120pcs	17.70kg	0.137kg
M47142	10mm(3/8")系列 250mm(10')	250mm	6pcs	60pcs	19.24kg	0.300kg

货号 Item No	规格 Size	L(总长) length	装盒数 Pc/Box	装箱数 Pc/Carton	毛重 GW/CTN	单支重 NW/PC
M47146	12.5mm(1/2")系列 75mm(3')	75mm	12pcs	120pcs	15.10kg	0.117kg
M47147	12.5mm(1/2")系列 125mm(5')	125mm	6pcs	48pcs	10.00kg	0.197kg
M47148	12.5mm(1/2")系列 250mm(10')	250mm	6pcs	48pcs	19.20kg	0.385kg
M47149	12.5mm(1/2")系列 300mm(12')	300mm	6pcs	36pcs	15.50kg	0.402kg



货号 Item No	规格 Size	装盒数 Pc/Box	装箱数 Pc/Carton	毛重 GW/CTN	单支重 NW/PC
M47153	20mm(3/4")系列 100mm(4')	6pcs	60pcs	25.40kg	0.40kg
M47154	20mm(3/4")系列 200mm(8')	2pcs	30pcs	23.00kg	0.73kg
M47155	20mm(3/4")系列 400mm(16')	2pcs	20pcs	28.50kg	1.35kg



货号 Item No	规格 Size	L(总长) length	装盒数 Pc/Box	装箱数 Pc/Carton	毛重 GW/CTN	单支重 NW/PC
M47160	25mm(1")系列 200mm(8')	200mm	2pcs	20pcs	27.00kg	1.30kg
M47161	25mm(1")系列 400mm(16')	400mm	2pcs	10pcs	24.60kg	2.38kg

- 适用于狭窄空间, 深度范围内操作
- 强度高, 不断裂, 不变形
- Used in narrow and deep area
- Strong strength, no defoemand rupture

万向接头

Universal Joint

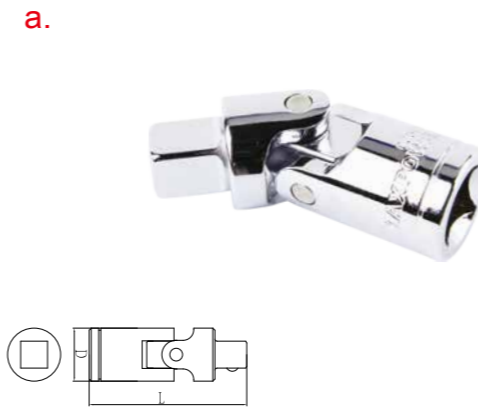

货号 Item No	规格 Size	L(总长) length	D	装盒数 Pc/Box	装箱数 Pc/Carton	毛重 GW/CTN	单支重 NW/PC
M47059	6.3mm(1/4")	39.5mm	13.7mm	64pcs	640pcs	18.80kg	0.027kg
M47060	10mm(3/8")	55mm	18mm	32pcs	320pcs	21.50kg	0.065kg
M47061	12.5mm(1/2")	75mm	25mm	12pcs	72pcs	11.40kg	0.150kg



货号 Item No	规格 Size	装盒数 Pc/Box	装箱数 Pc/Carton	毛重 GW/CTN	单支重 NW/PC
M48191	20mm(3/4") × 135mm(5.5')	30pcs	23.00kg	0.71kg	

- 可在狭窄空间操作, 使用方便
- Can be used in narrow area, easy to use

旋具头接头

Bit adapter



货号 Item No	规格 Size	F	装盒数 Pc/Box	装箱数 Pc/Carton	毛重 GW/CTN	单支重 NW/PC
M47076	6.3mm系列6.3mm	6.3mm	20pcs	600pcs	18.00kg	0.01kg
M47077	10mm系列8mm	10mm	30pcs	600pcs	13.50kg	0.02kg
M47078	12.5mm系列8mm	12.5mm	20pcs	400pcs	25.50kg	0.06kg

- 铬钒钢制造, 硬度可达 HRC50
- 建议配合MAXPOWER棘轮扳手及旋具头使用, 效果及寿命更佳
- Drop forged with CRV, heat treatment

三用接头

3-Way Adapter



货号 Item No	规格 (方孔边长 x 方榫系列) Size(F x M)	方孔 F	方头 M	装盒数 Pc/Box	装箱数 Pc/Carton	毛重 GW/CTN	单支重 NW/PC
M47026	10mmFx12.5mmM(3/8"Fx 1/2"M)	10mm	12.5mm	12pcs	96pcs	7.50kg	0.073kg
M47025	20mmFx25mmM(3/4"Fx 1"M)	20mm	25mm	2pcs	20pcs	8.00kg	0.37kg

- 可代替 L 杆, 变换规格, 使用更方便
- Can replace L bar, can replace different size

转换接头

Adapter



货号 Item No	规格 (方孔边长 x 方榫系列) Size(F x M)	装盒数 Pc/Box	装箱数 Pc/Carton	毛重 GW	单支重 NW/PC
M47040	6.3mmF × 10mmM(1/4"Fx 3/8"M)	30pcs	600pcs	10.00kg	0.017kg
M47043	10mmF × 6.3mmM(3/8"Fx 1/4"M)	50pcs	1000pcs	21.00kg	0.021kg
M47042	10mmF × 12.5mmM(3/8"Fx 1/2"M)	20pcs	400pcs	20.36kg	0.047kg
M47039	12.5mmF × 10mmM(1/2"Fx 3/8"M)	25pcs	500pcs	21.50kg	0.048kg
M47038	12.5mmF × 20mmM(1/2"Fx 3/4"M)	10pcs	60pcs	8.50kg	0.130kg
M47041	20mmF × 12.5mmM(3/4"Fx 1/2"M)	10pcs	50pcs	10.8kg	0.200kg

- 变换规格, 使用更方便
- Change sizes as you want, easy to use.

6.3mm 旋柄

Spinner Handle



货号 Item No	规格 Size	L(总长) length	装盒数 Pc/Box	装箱数 Pc/Carton	毛重 GW/CTN	单支重 NW/PC
M47185	150mm(6')	150mm	120pcs	11.00kg	0.084kg	

工具小常识

MAXPOWER 旋具套筒样式



6.3mm 系列花型旋具套筒
1/4"Dr.Torx Bit Socket

S2



货号 Item No	规格 Size	装盒数 Pc/Box	装箱数 Pc/Carton	毛重 GW	单支重 NW/PC
M 49005	T08	36pcs	720pcs	11.70kg	0.01kg
M 49006	T10	36pcs	720pcs	11.70kg	0.01kg
M 49007	T15	36pcs	720pcs	12.10kg	0.01kg
M 49008	T20	36pcs	720pcs	12.80kg	0.02kg
M 49009	T25	36pcs	720pcs	12.60kg	0.01kg
M 49010	T27	36pcs	720pcs	12.20kg	0.02kg
M 49011	T30	36pcs	720pcs	13.30kg	0.02kg
M 49012	T40	36pcs	720pcs	12.80kg	0.02kg

• 旋具头采用 S2 高级合金钢整体淬火, 不易断裂、打滑
• 总长: 38mm
• Bits are made of S2 ,overall quenched,not easy to break and slip · Length:38mm

6.3mm 系列十字旋具套筒
1/4"Dr.Phillips Bit Socket

S2



货号 Item No	规格 Size	装盒数 Pc/Box	装箱数 Pc/Carton	毛重 GW	单支重 NW/PC
M 49052	PH1	36pcs	720pcs	7.2kg	0.01kg
M 49053	PH2	36pcs	720pcs	14.4kg	0.02kg
M 49054	PH3	36pcs	720pcs	14.4kg	0.02kg

• 旋具头采用 S2 高级合金钢整体淬火, 不易断裂、打滑
• 总长: 38mm
• Bits are made of S2 ,overall quenched,not easy to break and slip · Length:38mm

6.3mm 系列米字旋具套筒
1/4"Dr.Pozidriv Bit Socket

S2



货号 Item No	规格 Size	装盒数 Pc/Box	装箱数 Pc/Carton	毛重 GW	单支重 NW/PC
M 49065	PZ1	36pcs	720pcs	11.90kg	0.01kg
M 49066	PZ2	36pcs	720pcs	12.10kg	0.02kg
M 49067	PZ3	36pcs	720pcs	12.30kg	0.02kg

• 旋具头采用 S2 高级合金钢整体淬火, 不易断裂、打滑
• 总长: 38mm
• Bits are made of S2 ,overall quenched,not easy to break and slip · Length:38mm

6.3mm 系列 6 角旋具套筒
1/4"Dr.Hexagon Bit Socket

S2



货号 Item No	规格 Size	装盒数 Pc/Box	装箱数 Pc/Carton	毛重 GW	单支重 NW/PC
M 49023	H3	36pcs	720pcs	11.90kg	0.01kg
M 49024	H4	36pcs	720pcs	12.10kg	0.02kg
M 49025	H5	36pcs	720pcs	12.60kg	0.02kg
M 49026	H6	36pcs	720pcs	13.60kg	0.02kg
M 49027	H7	36pcs	720pcs	13.70kg	0.02kg
M 49028	H8	36pcs	720pcs	14.40kg	0.02kg

• 旋具头采用 S2 高级合金钢整体淬火, 不易断裂、打滑
• 总长: 38mm
• Bits are made of S2 ,overall quenched,not easy to break and slip · Length:38mm

6.3mm 系列一字旋具套筒
1/4"Dr.Slotted Bit Socket

S2



货号 Item No	规格 Size	装盒数 Pc/Box	装箱数 Pc/Carton	毛重 GW	单支重 NW/PC
M 49039	SL4.0	36pcs	720pcs	11.60kg	0.01kg
M 49040	SL5.5	36pcs	720pcs	12.80kg	0.02kg
M 49041	SL6.5	36pcs	720pcs	12.40kg	0.02kg

• 旋具头采用 S2 高级合金钢整体淬火, 不易断裂、打滑
• 总长: 38mm
• Bits are made of S2 ,overall quenched,not easy to break and slip · Length:38mm

10mm 系列米字旋具套筒
3/8"Dr.Pozidriv Bit Socket

S2



货号 Item No	规格 Size	装盒数 Pc/Box	装箱数 Pc/Carton	毛重 GW	单支重 NW/PC
M 49190	PZ1	25pcs	500pcs	19.00kg	0.04kg
M 49191	PZ2	25pcs	500pcs	19.40kg	0.04kg
M 49192	PZ3	25pcs	500pcs	19.80kg	0.04kg
M 49193	PZ4	25pcs	500pcs	21.10kg	0.04kg

• 旋具头采用 S2 高级合金钢整体淬火, 不易断裂、打滑
• 总长: 50mm
• Bits are made of S2 ,overall quenched,not easy to break and slip · Length : 50mm

10mm 系列花型旋具套筒
3/8"Dr.Torx Bit Socket

S2



货号 Item No	规格 Size	装盒数 Pc/Box	装箱数 Pc/Carton	毛重 GW	单支重 NW/PC
M 49120	T10	25pcs	500pcs	18.90kg	0.04kg
M 49121	T15	25pcs	500pcs	18.90kg	0.04kg
M 49122	T20	25pcs	500pcs	19.10kg	0.04kg
M 49123	T25	25pcs	500pcs	19.20kg	0.04kg
M 49124	T27	25pcs	500pcs	19.10kg	0.04kg
M 49125	T30	25pcs	500pcs	19.70kg	0.04kg
M 49126	T40	25pcs	500pcs	29.70kg	0.04kg
M 49127	T45	25pcs	500pcs	29.40kg	0.04kg
M 49128	T50	25pcs	500pcs	21.10kg	0.04kg
M 49129	T55	20pcs	400pcs	18.30kg	0.04kg
M 49130	T60	20pcs	400pcs	19.90kg	0.05kg

• 旋具头采用 S2 高级合金钢整体淬火, 不易断裂、打滑
• 总长: 50mm
• Bits are made of S2 ,overall quenched,not easy to break and slip · Length : 50mm

10mm 系列 6 角旋具套筒
3/8"Dr.Hexagon Bit Socket

S2



货号 Item No	规格 Size	装盒数 Pc/Box	装箱数 Pc/Carton	毛重 GW	单支重 NW/PC
M 49141	H3	25pcs	500pcs	19.30kg	0.04kg
M 49142	H4	25pcs	500pcs	19.60kg	0.04kg
M 49143	H5	25pcs	500pcs	19.90kg	0.04kg
M 49144	H6	25pcs	500pcs	20.70kg	0.04kg
M 49145	H7	25pcs	500pcs	21.70kg	0.04kg
M 49146	H8	20pcs	400pcs	17.00kg	0.04kg
M 49147	H10	20pcs	400pcs	18.90kg	0.04kg

• 旋具头采用 S2 高级合金钢整体淬火, 不易断裂、打滑
• 总长: 50mm
• Bits are made of S2 ,overall quenched,not easy to break and slip · Length : 50mm

10mm 系列中孔花型旋具套筒
3/8"Dr.Tamper Proof Torx Bit Socket

S2



货号 Item No	规格 Size	装盒数 Pc/Box	装箱数 Pc/Carton	毛重 GW	单支重 NW/PC
M 49204	T10	25pcs	500pcs	19.00kg	0.04kg
M 49205	T15	25pcs	500pcs	19.00kg	0.04kg
M 49206	T20	25pcs	500pcs	18.90kg	0.04kg
M 49207	T25	25pcs	500pcs	19.10kg	0.04kg
M 49208	T27	25pcs	500pcs	19.30kg	0.04kg
M 49209	T30	25pcs	500pcs	19.30kg	0.04kg
M 49210	T40	25pcs	500pcs	19.80kg	0.04kg
M 49211	T45	25pcs	500pcs	20.10kg	0.04kg
M 49212	T50	25pcs	500pcs	20.60kg	0.04kg
M 49213	T55	20pcs	400pcs	17.60kg	0.04kg
M 49214	T60	20pcs	400pcs	19.00kg	0.04kg

• 旋具头采用 S2 高级合金钢整体淬火, 不易断裂、打滑
• 总长: 50mm
• Bits are made of S2 ,overall quenched,not easy to break and slip · Length : 50mm

10mm 系列十字旋具套筒
3/8"Dr.Phillips Bit Socket

S2



货号 Item No	规格 Size	装盒数 Pc/Box	装箱数 Pc/Carton	毛重 GW	单支重 NW/PC
M 49176	PH1	25pcs	500pcs	18.80kg	0.04kg
M 49177	PH2	25pcs	500pcs	18.90kg	0.04kg
M 49178	PH3	25pcs	500pcs	20.70kg	0.04kg
M 49179	PH4	25pcs	500pcs	20.40kg	0.04kg

• 旋具头采用 S2 高级合金钢整体淬火, 不易断裂、打滑
• 总长: 50mm
• Bits are made of S2 ,overall quenched,not easy to break and slip · Length : 50mm

10mm 系列一字旋具套筒
3/8"Dr.Slotted Bit Socket

S2



货号 Item No	规格 Size	装盒数 Pc/Box	装箱数 Pc/Carton	毛重 GW	单支重 NW/PC
M 49158	SL3.5	25pcs	500pcs	14.30kg	0.03kg
M 49159	SL4.0	25pcs	500pcs	18.60kg	0.03kg
M 49160	SL4.5	25pcs	500pcs	18.60kg	0.03kg
M 49161	SL5.5	25pcs	500pcs	19.40kg	0.04kg
M 49162	SL6.5	25pcs	500pcs	19.50kg	0.04kg
M 49163	SL7.0	20pcs	400pcs	15.90kg	0.04kg
M 49164	SL8.0	20pcs	400pcs	16.30kg	0.04kg
M 49165	SL10.0	20pcs	400pcs	17.20kg	0.04kg

• 旋具头采用 S2 高级合金钢整体淬火, 不易断裂、打滑
• 总长: 50mm
• Bits are made of S2 ,overall quenched,not easy to break and slip · Length : 50mm

12.5mm 系列 12 角旋具套筒
1/2"Dr.Spline Bit Socket

S2



货号 Item No	规格 Size	装盒数 Pc/Box	装箱数 Pc/Carton	毛重 GW	单支重 NW/PC
M 49320	M5	30pcs	300pcs	20.90kg	0.07kg
M 49321	M6	30pcs	300pcs	21.00kg	0.07kg
M 49322	M8	30pcs	300pcs	21.30kg	0.07kg
M 49323	M10	30pcs	300pcs	24.10kg	0.08kg
M 49324	M12	20pcs	200pcs	16.40kg	0.08kg
M 49325	M14	20pcs	200pcs	16.40kg	0.08kg
M 49326	M16	20pcs	200pcs	30.00kg	0.15kg

• 旋具头采用 S2 高级合金钢整体淬火, 不易断裂、打滑 · 总长: 55mm
• Bits are made of S2 ,overall quenched,not easy to break and slip · Length : 55mm

12.5mm 系列一字型旋具套筒
1/2"Dr.Slotted Bit Socket

S2



货号 Item No	规格 Size	装盒数 Pc/Box	装箱数 Pc/Carton	毛重 GW	单支重 NW/PC
M 49306	SL6.5	30pcs	300pcs	21.70kg	0.07kg
M 49307	SL8.0	30pcs	300pcs	20.10kg	0.06kg
M 49308	SL10	30pcs	300pcs	20.90kg	0.07kg
M 49309	SL12	30pcs	300pcs	21.50kg	0.07kg

• 旋具头采用 S2 高级合金钢整体淬火, 不易断裂、打滑 · 总长: 55mm
• Bits are made of S2 ,overall quenched,not easy to break and slip · Length : 55mm

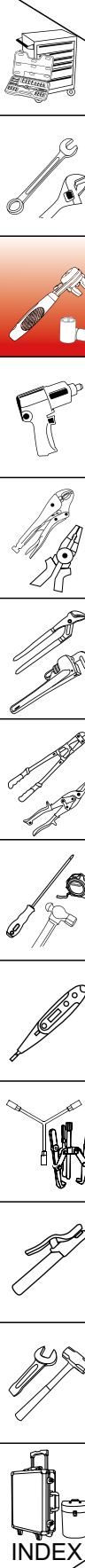

INDEX

12.5mm 系列花型旋具套筒
1/2"Dr.Torx Bit Socket



货号 Item No	规格 Size	装盒数 Pc/Box	装箱数 Pc/Carton	毛重 GW	单支重 NW/PC
M 49267	T20	30pcs	300pcs	20.40kg	0.06kg
M 49268	T25	30pcs	300pcs	21.50kg	0.07kg
M 49269	T27	30pcs	300pcs	20.60kg	0.07kg
M 49270	T30	30pcs	300pcs	20.70kg	0.07kg
M 49271	T40	30pcs	300pcs	20.10kg	0.06kg
M 49272	T45	30pcs	300pcs	20.10kg	0.06kg
M 49273	T50	30pcs	300pcs	22.10kg	0.07kg
M 49274	T55	25pcs	250pcs	20.50kg	0.07kg
M 49275	T60	25pcs	250pcs	23.20kg	0.07kg

• 旋具头采用 S2 高级合金钢整体淬火, 不易断裂、打滑
• 总长: 55mm
• Bits are made of S2 ,overall quenched,not easy to break and slip
• Length : 55mm

12.5mm 花型中孔旋具套筒
1/2"Dr.Tamper Proof Torx Bit Socket



货号 Item No	规格 Size	装盒数 Pc/Box	装箱数 Pc/Carton	毛重 GW	单支重 NW/PC
M 49337	T10	30pcs	300pcs	15.40kg	0.06kg
M 49338	T15	30pcs	300pcs	15.40kg	0.06kg
M 49339	T20	30pcs	300pcs	20.40kg	0.06kg
M 49340	T25	30pcs	300pcs	20.90kg	0.07kg
M 49341	T27	30pcs	300pcs	20.60kg	0.07kg
M 49342	T30	30pcs	300pcs	20.70kg	0.07kg
M 49343	T40	30pcs	300pcs	21.30kg	0.06kg
M 49344	T45	30pcs	300pcs	21.90kg	0.06kg
M 49345	T50	30pcs	300pcs	21.60kg	0.07kg
M 49346	T55	25pcs	250pcs	20.00kg	0.07kg
M 49347	T60	25pcs	250pcs	18.90kg	0.07kg

• 旋具头采用 S2 高级合金钢整体淬火, 不易断裂、打滑
• 总长: 55mm
• Bits are made of S2 ,overall quenched,not easy to break and slip
• Length : 55mm

12.5mm 系列 6 角旋具套筒
1/2"Dr.Hexagon Bit Socket



货号 Item No	规格 Size	装盒数 Pc/Box	装箱数 Pc/Carton	毛重 GW	单支重 NW/PC
M 49286	H4	30pcs	300pcs	20.50kg	0.07kg
M 49287	H5	30pcs	300pcs	20.90kg	0.07kg
M 49288	H6	30pcs	300pcs	21.00kg	0.07kg
M 49289	H7	30pcs	300pcs	22.20kg	0.06kg
M 49290	H8	30pcs	300pcs	21.90kg	0.07kg
M 49291	H10	30pcs	300pcs	22.60kg	0.07kg
M 49292	H12	20pcs	200pcs	16.30kg	0.08kg
M 49293	H14	20pcs	200pcs	19.80kg	0.09kg
M 49294	H17	15pcs	150pcs	21.70kg	0.16kg
M 49295	H19	15pcs	150pcs	25.60kg	0.16kg

• 旋具头采用 S2 高级合金钢整体淬火, 不易断裂、打滑
• 总长: 55mm
• Bits are made of S2 ,overall quenched,not easy to break and slip
• Length : 55mm

12.5mm 系列长花型旋具套筒
1/2"Dr. Deep Torx Bit Socket



货号 Item No	规格 Size	装盒数 Pc/Box	装箱数 Pc/Carton	毛重 GW	单支重 NW/PC
M 49378	T20	20pcs	200pcs	18.5kg	0.083kg
M 49379	T25	20pcs	200pcs	18.7kg	0.085kg
M 49380	T27	20pcs	200pcs	18.5kg	0.085kg
M 49381	T30	20pcs	200pcs	17.9kg	0.085kg
M 49382	T40	20pcs	200pcs	19.0kg	0.086kg
M 49383	T45	10pcs	100pcs	9.40kg	0.084kg
M 49384	T50	10pcs	100pcs	9.40kg	0.084kg
M 49385	T55	10pcs	100pcs	10.90kg	0.099kg
M 49386	T60	10pcs	100pcs	12.50kg	0.115kg

• 旋具头采用 S2 高级合金钢整体淬火, 不易断裂、打滑
• 总长: 100mm
• Bits are made of S2 ,overall quenched,not easy to break and slip
• Length : 100mm

12.5mm 系列长 12 角旋具套筒
1/2"Dr. Deep Spline Bit Socket



货号 Item No	规格 Size	装盒数 Pc/Box	装箱数 Pc/Carton	毛重 GW	单支重 NW/PC
M 49416	M5	20pcs	200pcs	17.30kg	0.081kg
M 49417	M6	20pcs	200pcs	18.10kg	0.086kg
M 49418	M8	20pcs	200pcs	18.30kg	0.086kg
M 49419	M10	15pcs	150pcs	16.50kg	0.104kg
M 49420	M12	15pcs	150pcs	20.80kg	0.135kg
M 49421	M14	10pcs	100pcs	16.20kg	0.149kg
M 49422	M16	10pcs	100pcs	22.50kg	0.215kg

• 旋具头采用 S2 高级合金钢整体淬火, 不易断裂、打滑
• 总长: 100mm
• Bits are made of S2 ,overall quenched,not easy to break and slip
• Length : 100mm

12.5mm 系列长 6 角旋具套筒
1/2"Dr.Deep Hexagon Bit Socket



货号 Item No	规格 Size	装盒数 Pc/Box	装箱数 Pc/Carton	毛重 GW	单支重 NW/PC
M 49397	H4	20pcs	200pcs	17.10kg	0.081kg
M 49398	H5	20pcs	200pcs	18.70kg	0.085kg
M 49399	H6	20pcs	200pcs	18.30kg	0.086kg
M 49400	H7	20pcs	200pcs	18.40kg	0.087kg
M 49401	H8	20pcs	200pcs	18.10kg	0.086kg
M 49402	H10	15pcs	150pcs	16.80kg	0.105kg
M 49403	H12	15pcs	150pcs	18.40kg	0.116kg
M 49404	H14	10pcs	100pcs	16.50kg	0.155kg
M 49405	H17	10pcs	100pcs	22.80kg	0.218kg

• 旋具头采用 S2 高级合金钢整体淬火, 不易断裂、打滑
• 总长: 100mm
• Bits are made of S2 ,overall quenched,not easy to break and slip
• Length : 100mm

气动类工具

Pneumatic Tools

气动套筒..... 70-71
 气动砂轮机..... 73
 气动双头旋具头..... 73
 气钻..... 73
 气扳机..... 73-74
 Impact Sockets..... 70-71
 Air Grinding..... 73
 Air Two Head Bits..... 73
 Air Drill..... 73
 Air Impact Wrench..... 73-74



气动套筒 Impact Socket

CR-MO



- 优质铬钼钢锻造，特殊热处理工艺，经久耐用强度高
- 通过德国 VPA/GS 认证
- Cr-Mo Steel, drop forged, special heat treatment, with high durability and intensity
- VPA/GS approval

12.5mm系列气动套筒 (1/2" Dr. Impact Sockets)

货号 Item No	规格 Size	总长 length	装箱数 Pc/Box	装箱数 Pc/ Carton	毛重 GW/CTN	单支重 NW/PC
M 51308	8mm	38mm	12pcs	240pcs	16.30kg	0.062kg
★ M 51309	9mm	38mm	12pcs	240pcs	16.30kg	0.062kg
M 51310	10mm	38mm	12pcs	240pcs	15.60kg	0.060kg
M 51311	11mm	38mm	12pcs	240pcs	16.50kg	0.064kg
M 51312	12mm	38mm	12pcs	240pcs	20.40kg	0.081kg
M 51313	13mm	38mm	12pcs	240pcs	20.30kg	0.079kg
M 51314	14mm	38mm	12pcs	240pcs	20.00kg	0.078kg
M 51315	15mm	38mm	12pcs	240pcs	20.70kg	0.082kg
M 51316	16mm	38mm	12pcs	240pcs	19.90kg	0.079kg
M 51317	17mm	38mm	12pcs	240pcs	25.00kg	0.093kg
M 51318	18mm	38mm	12pcs	240pcs	28.20kg	0.112kg
M 51319	19mm	38mm	12pcs	240pcs	21.66kg	0.085kg
★ M 51320	20mm	38mm	12pcs	72pcs	9.70kg	0.127kg
M 51321	21mm	38mm	12pcs	72pcs	6.88kg	0.086kg
M 51322	22mm	38mm	12pcs	72pcs	9.18kg	0.122kg
M 51323	23mm	38mm	12pcs	72pcs	12.90kg	0.161kg
M 51324	24mm	38mm	12pcs	72pcs	9.84kg	0.130kg
★ M 51325	25mm	42mm	12pcs	72pcs	14.80kg	0.215kg
★ M 51326	26mm	42mm	12pcs	72pcs	13.30kg	0.216kg
M 51327	27mm	43mm	12pcs	72pcs	16.00kg	0.215kg
★ M 51328	28mm	44mm	12pcs	72pcs	19.80kg	0.236kg
★ M 51329	29mm	44mm	12pcs	72pcs	19.40kg	0.238kg
M 51330	30mm	44mm	12pcs	72pcs	12.70kg	0.185kg
M 51332	32mm	44mm	12pcs	72pcs	16.60kg	0.220kg

注: ★为不常用规格

20mm系列气动套筒 (3/4" Dr. Impact Sockets)

货号 Item No	规格 Size	总长 length	装箱数 Pc/Box	装箱数 Pc/ Carton	毛重 GW/CTN	单支重 NW/PC
M 52317	17mm	50mm	48pcs	11.50kg	0.220kg	
M 52318	18mm	50mm	48pcs	11.60kg	0.220kg	
M 52319	19mm	50mm	48pcs	11.80kg	0.225kg	
★ M 52320	20mm	50mm	48pcs	16.00kg	0.300kg	
M 52321	21mm	50mm	48pcs	12.10kg	0.230kg	
M 52322	22mm	50mm	48pcs	12.50kg	0.240kg	
★ M 52323	23mm	50mm	48pcs	12.80kg	0.250kg	
M 52324	24mm	50mm	48pcs	12.70kg	0.250kg	
★ M 52325	25mm	52mm	48pcs	13.20kg	0.250kg	
★ M 52326	26mm	52mm	48pcs	13.30kg	0.250kg	
M 52327	27mm	52mm	48pcs	15.80kg	0.310kg	
★ M 52328	28mm	52mm	32pcs	10.86kg	0.310kg	
★ M 52329	29mm	52mm	32pcs	9.90kg	0.290kg	
M 52330	30mm	52mm	32pcs	9.86kg	0.275kg	
★ M 52331	31mm	55mm	32pcs	12.00kg	0.340kg	
M 52332	32mm	55mm	32pcs	11.90kg	0.342kg	
★ M 52333	33mm	57mm	32pcs	15.20kg	0.450kg	
M 52334	34mm	57mm	32pcs	14.60kg	0.423kg	
★ M 52335	35mm	57mm	32pcs	15.90kg	0.456kg	

注: ★为不常用规格

(接上列 20mm系列气动套筒)

货号 Item No	规格 Size	总长 length	装箱数 Pc/ Carton	毛重 GW/CTN	单支重 NW/PC
M 52336	36mm	57mm	32pcs	16.84kg	0.45kg
★ M 52338	38mm	57mm	32pcs	18.60kg	0.55kg
M 52340	40mm	63mm	16pcs	11.20kg	0.64kg
M 52341	41mm	63mm	16pcs	10.70kg	0.62kg
★ M 52343	43mm	63mm	16pcs	11.50kg	0.67kg
★ M 52345	45mm	68mm	16pcs	12.70kg	0.74kg
M 52346	46mm	68mm	16pcs	13.00kg	0.73kg
★ M 52348	48mm	68mm	16pcs	14.00kg	0.79kg
M 52350	50mm	72mm	16pcs	17.20kg	1.01kg
★ M 52352	52mm	72mm	10pcs	11.20kg	1.09kg
★ M 52354	54mm	75mm	10pcs	10.94kg	1.07kg
M 52355	55mm	75mm	10pcs	10.90kg	1.07kg
★ M 52357	57mm	75mm	10pcs	13.00kg	1.27kg
★ M 52358	58mm	77mm	10pcs	15.24kg	1.48kg
★ M 52359	59mm	77mm	10pcs	14.40kg	1.40kg
M 52360	60mm	77mm	10pcs	14.66kg	1.42kg
★ M 52363	63mm	80mm	10pcs	13.40kg	1.27kg
M 52365	65mm	85mm	6pcs	17.30kg	1.68kg
M 52370	70mm	85mm	6pcs	10.38kg	1.68kg
M 52375	75mm	85mm	6pcs	13.10kg	2.13kg
M 52380	80mm	85mm	6pcs	19.00kg	2.91kg

注: ★为不常用规格

25mm系列气动套筒 (1" Dr. Impact Sockets)

货号 Item No	规格 Size	总长 length	装箱数 Pc/ Carton	毛重 GW/CTN	单支重 NW/PC
M 53336	36mm	65mm	30pcs	22.90kg	0.68kg
★ M 53338	38mm	65mm	30pcs	23.84kg	0.74kg
M 53340	40mm	68mm	20pcs	18.60kg	0.87kg
M 53341	41mm	70mm	20pcs	18.60kg	0.86kg
★ M 53343	43mm	70mm	20pcs	20.00kg	0.92kg
★ M 53345	45mm	70mm	20pcs	20.70kg	0.97kg
M 53346	46mm	70mm	20pcs	20.10kg	0.94kg
★ M 53348	48mm	70mm	20pcs	22.30kg	1.03kg
M 53350	50mm	75mm	20pcs	24.00kg	1.11kg
★ M 53352	52mm	80mm	20pcs	26.30kg	1.22kg
★ M 53354	54mm	80mm	20pcs	27.20kg	1.28kg
M 53355	55mm	80mm	20pcs	27.70kg	1.28kg
★ M 53357	57mm	82mm	12pcs	29.00kg	1.40kg
★ M 53358	58mm	82mm	12pcs	19.80kg	1.55kg
★ M 53359	59mm	82mm	12pcs	19.30kg	1.49kg
M 53360	60mm	82mm	12pcs	20.40kg	1.52kg
★ M 53363	63mm	87mm	12pcs	20.00kg	1.88kg
M 53365	65mm	87mm	12pcs	22.80kg	1.75kg
M 53370	70mm	94mm	8pcs	18.50kg	2.16kg
M 53375	75mm	100mm	8pcs	28.50kg	3.43kg
M 53380	80mm	103mm	8pcs	24.60kg	2.90kg

注: ★为不常用规格



气动长套筒 Deep Impact Socket

CR-MO



- 优质铬钼钢锻造，特殊热处理工艺，经久耐用强度高
- 通过德国 VPA/GS 认证
- Cr-Mo Steel, drop forged, special heat treatment, with high durability and intensity
- VPA/GS approval

12.5mm系列气动长套筒 (1/2" Dr. Deep Impact Sockets)

货号 Item No	规格 Size	总长 length	装箱数 Pc/Box	装箱数 Pc/ Carton	毛重 GW/CTN	单支重 NW/PC
M 51407	8mm	78 mm	16 pcs	192pcs	26.1kg	0.13kg
★ M 51408	9mm	78 mm	16 pcs	192pcs	26.5kg	0.13kg
M 51409	10mm	78 mm	16 pcs	192pcs	27.3kg	0.13kg
M 51410	11mm	78 mm	16 pcs	192pcs	27.7kg	0.14kg
M 51411	12mm	78 mm	16 pcs	192pcs	29.8kg	0.15kg
M 51412	13mm	78 mm	16 pcs	192pcs	31.6kg	0.15kg
M 51413	14mm	78 mm	16 pcs	128pcs	21.5kg	0.16kg
M 51414	15mm	78 mm	16 pcs	128pcs	22.8kg	0.17kg
M 51415	16mm	78 mm	16 pcs	128pcs	20.8kg	0.15kg
M 51416	17mm	78 mm	16 pcs	128pcs	24.6kg	0.18kg
M 51417	18mm	78 mm	9 pcs	108pcs	23.8kg	0.20kg
M 51418	19mm	78 mm	9 pcs	108pcs	22.3kg	0.20kg
★ M 51419	20mm	78 mm	9 pcs	72pcs	16.8kg	0.21kg
M 51420	21mm	78 mm	9 pcs	72pcs	16.5kg	0.21kg
M 51421	22mm	78 mm	9 pcs	72pcs	20.0kg	0.27kg
M 51422	23mm	78 mm	8 pcs	64pcs	20.5kg	0.30kg
M 51423	24mm	78 mm	8 pcs	64pcs	19.2kg	0.28kg
★ M 51424	25mm	78 mm	8 pcs	64pcs	22.0kg	0.29kg
★ M 51425	26mm	78 mm	8 pcs	64pcs	23.5kg	0.35kg
M 51426	27mm	78 mm	4 pcs	48pcs	17.2kg	0.32kg
★ M 51427	28mm	78 mm	4 pcs	48pcs	19.5kg	0.37kg
★ M 51428	29mm	78 mm	4 pcs	48pcs	18.9kg	0.37kg
M 51429	30mm	78 mm	4 pcs	48pcs	20.5kg	0.40kg
M 51431	32mm	78mm	4 pcs	48pcs	21.5kg	0.42kg

注: ★为不常用规格

20mm系列气动长套筒 (3/4" Dr. Deep Impact Sockets)

货号 Item No	规格 Size	总长 length	装箱数 Pc/ Carton	毛重 GW/CTN	单支重 NW/PC
M 52416	17mm	90mm	30pcs	16.00kg	0.46kg
M 52417	18mm	90mm	30pcs	16.00kg	0.47kg
M 52418	19mm	90mm	30pcs	16.00kg	0.47kg
M 52420	21mm	90mm	30pcs	16.50kg	0.50kg
M 52421	22mm	90mm	30pcs	17.00kg	0.51kg
★ M 52422	23mm	90mm	30pcs	17.50kg	0.51kg
M 52423	24mm	90mm	30pcs	17.50kg	0.52kg
★ M 52424	25mm	90mm	30pcs	18.00kg	0.56kg
★ M 52425	26mm	90mm	30pcs	20.00kg	0.57kg
M 52426	27mm	90mm	30pcs	22.00kg	0.68kg
★ M 52427	28mm	90mm	30pcs	23.00kg	0.73kg
M 52429	30mm	90mm	30pcs	24.50kg	0.76kg
M 52431	32mm	90mm	30pcs	25.00kg	0.80kg
★ M 52432	33mm	90mm	30pcs	26.00kg	0.83kg
M 52433	34mm	90mm	30pcs	26.50kg	0.84kg
M 52435	36mm	90mm	30pcs	28.00kg	0.88kg
M 52440	41mm	90mm	10pcs	11.00kg	1.01kg
M 52445	46mm	90mm	10pcs	13.00kg	1.26kg
M 52449	50mm	90mm	10pcs	14.00kg	1.30kg
M 52454	55mm	90mm	10pcs	16.00kg	1.49kg
M 52459	60mm	90mm	8pcs	15.00kg	1.72kg
M 52464	65mm	90mm	8pcs	16.00kg	1.81kg

注: ★为不常用规格

25mm系列气动长套筒 (1" Dr. Deep Impact Sockets)

货号 Item No	规格 Size	总长 length	装箱数 Pc/ Carton	毛重 GW/CTN	单支重 NW/PC
M 53435	36mm	90mm	30pcs	27.00kg	0.86kg
M 53440	41mm	100mm	30pcs	30.00kg	0.97kg
M 53445	46mm	100mm	24pcs	33.00kg	1.33kg
M 53449	50mm	100mm	15pcs	30.00kg	1.82kg
M 53454	55mm	100mm	12pcs	26.00kg	2.08kg
M 53459	60mm	120mm	10pcs	25.00kg	2.41kg
M 53464	65mm	120mm	8pcs	28.00kg	3.26kg
M 53469	70mm	125mm	8pcs	29.00kg	3.50kg
M 53474	75mm	125mm	8pcs	31.00kg	3.66kg
M 53479	80mm	125mm	8pcs	33.00kg	3.90kg
M 53484	85mm	125mm	8pcs	35.00kg	4.25kg

12.5mm系列整体气动六角旋具套筒 1/2" Dr. 6 Point Impact Hex Socket

CR-MO

NEW



- 整体采用Cr-Mo钢冷锻成型
- 整体热处理，强度高，抗冲击
- 磷化表面防锈处理，抗氧化，耐腐蚀

货号 Item No	规格 Size	总长 length	装箱数 Pc/Box	装箱数 Pc/ Carton	单支重 NW/PC	毛重 GW/CTN
M 54104	H4	78mm	100pcs	100pcs	0.07kg	8.70kg
M 54105	H5	78mm	100pcs	100pcs	0.08kg	9.75kg
M 54106	H6	78mm	100pcs	100pcs	0.09kg	9.90kg
M 54107	H7	78mm	100pcs	100pcs	0.09kg	9.89kg
M 54108	H8	78mm	100pcs	100pcs	0.09kg	10.25kg
M 54109	H9	78mm	100pcs	100pcs	0.10kg	11.00kg
M 54110	H10	78mm	100pcs	100pcs	0.11kg	11.95kg

气动接杆

Impact Extension Bar

CR-MO

NEW



·采用铬钼钢 (Cr-Mo) 冷墩处理, 耐强力冲击

货号 Item No	规格 Size	装盒数 Pc/Box	装箱数 Pc/Carton	单支重 NW/PC	毛重 GW/CTN
M 54080	10mmx75mm	12pcs	240pcs	0.076kg	19.0kg
M 54081	10mmx150mm	12pcs	120pcs	0.150kg	18.5kg
M 54083	12.5mmx125mm	6pcs	48pcs	0.217kg	11.0kg
M 54085	12.5mmx250mm	6pcs	48pcs	0.430kg	21.0kg
M 54088	20mmx175mm	1pc	30pcs	0.68kg	20.4kg
M 54089	20mmx250mm	1pc	16pcs	0.90kg	14.4kg
M 54092	25mmx200mm	1pc	12pcs	1.72kg	20.64kg

气动万向节

Impact Universal Joint

CR-MO

NEW



·采用铬钼钢(Cr-Mo), 冷墩处理, 耐冲击
·万向球头设计, 能满足不同角度的使用需求

货号 Item No	规格 Size	装盒数 Pc/Box	装箱数 Pc/Carton	单支重 NW/PC	毛重 GW/CTN
M 54059	10mm	8 pcs	192 pcs	0.09 kg	18.28 kg
M 54060	12.5mm	6 pcs	96 pcs	0.17 kg	17.32 kg
M 54061	20mm	2 pcs	32 pcs	0.59 kg	19.88 kg
M 54062	25mm	1 pc	20 pcs	1.05 kg	22.00 kg

气动O型安全防护圈

Impact O-Ring

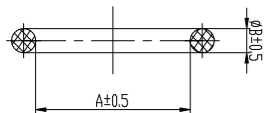

货号 Item No	规格 (AxB) Size	货号 Item No	规格 (AxB) Size
M 99200	15x3.5mm	M 99206	30x5mm
M 99201	18x3.5mm	M 99207	35x5mm
M 99202	19x3.5mm	M 99208	45x7mm
M 99203	20x4mm	M 99209	74x10mm
M 99204	22x4mm	M 99210	76x7mm
M 99205	25x4mm	M 99211	84x10mm

- 每袋5个
- 丁腈橡胶NBR材质, 符合欧盟检测标准
- 邵氏硬度Shore A70-75
- 承受较强冲击力, 有效防护气动元件销子脱落
- △本品属于易耗品, 不属于终身保用范围
- 5pcs/bag
- Made of nitrile rubber, comply with EU testing standards.
- Shore Hardness A70 - 75.
- Strong impact resistance, effectively protects pneumatic components from falling off.
- △ No warranty as consumables

气动安全防护销

Pneumatic Safty Pin

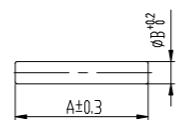

货号 Item No	规格 (AxB) Size	货号 Item No	规格 (AxB) Size
M 99220	14.8x2.5mm	M 99226	31x4mm
M 99221	17.8x2.5mm	M 99227	35x4mm
M 99222	19x2.5mm	M 99228	45x5mm
M 99223	20x3mm	M 99229	75x6mm
M 99224	25x3mm	M 99230	77x5mm
M 99225	22x3mm	M 99231	84x6mm

- 每袋5个
- 优质碳素结构钢材质
- 洛氏硬度HRC40-48
- 符合ISO2725-2标准
- 承受较强冲击力, 有效锁紧气动元器件
- △本品属于易耗品, 不属于终身保用范围
- 5pcs/bag
- High quality Carbon steel
- HRC40-48
- Meeting ISO2725-2 Standard
- Bearing stronger impact force, can lock Pneumatic components well.
- △ No warranty as consumables

6.3mm 系列 65mm 长气动双头旋具头

1/4" dr. 65mm long air impact double head bits

S2



货号 Item No	规格 Size	装盒数 Pc/Box	装箱数 Pc/Carton	毛重 GW/CTN	单支重 NW/PC
M 50821	PH1 x PH1	100pcs	1800pcs	25.30kg	0.014kg
M 50822	PH1 x PH2	100pcs	1800pcs	25.90kg	0.014kg
M 50823	PH2 x PH2	100pcs	1800pcs	25.90kg	0.014kg
M 50824	PH2 x PH3	100pcs	1800pcs	25.90kg	0.014kg
M 50825	PH3 x PH3	100pcs	1800pcs	25.90kg	0.014kg
M 50831	SL4.5 x PH1	100pcs	1800pcs	25.00kg	0.013kg
M 50832	SL5.5 x PH2	100pcs	1800pcs	26.20kg	0.014kg
M 50833	SL6.5 x PH3	100pcs	1800pcs	26.90kg	0.014kg

- 优质 S2 钢材加工而成, 扭力强, 硬度 HRC56-61, 扭矩超美标 50%
- Made of super alloy steel S2, hardness HRC56-61

3/8"系列专业级双向式气钻

Air Drill



货号 Item No	M 50135	进气口尺寸 Air Inter	1/4"
装箱数 Pc/Carton	12pcs	管子尺寸 Hose Size	3/8"
空载转速 RPM Free Speed	2000	最小耗气量 Consumption CFM	4CFM
夹头尺寸 Chuck Size	3/8"	长度 Length	195mm
主轴纹 Spindle Thread	2003/8/24	机重 Single Weight	1kg

125mm 角式气动砂轮机

Air Grinding Tool



货号 Item No	M 50159
装箱数 Pc/Carton	6pcs
空载转速 No-load Speed	12000r.p.m
砂轮尺寸 grinding wheel size	125mm
主轴纹 spindle thread	M14X2.0
进气口尺寸 air inter	1/4"
管子尺寸 hose size	3/8"
最小耗气量 consumption CFM	4CFM
长度 length	239mm
机重 Single Weight	2.00kg

- △ 本品属于易耗品, 不属于终身保用范围
- △ No warranty as consumables

1/2"系列迷你气扳机

Air Impact Wrench



货号 Item No	M 50120	工作范围 working torwue	34-434N.m
规格 Size	1/2" (13mm)	进气口尺寸 air inter	1/4"
装箱数 Pc/Carton	12pcs	管子尺寸 hose size	3/8"
空载转速 RPM Free Speed	8000	最小耗气量 consumption CFM	5.8CFM
驱动尺寸 anvil size	1/2"	长度 length	98mm
最大扭矩 maximum torque	678N.m	机重 Single Weight	1.11kg

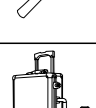
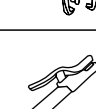
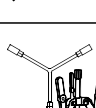
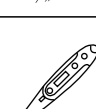
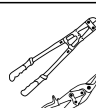
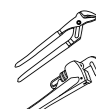
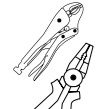

INDEX

1/2"系列复合材料大扭力气扳机
Air Impact Wrench



货号 Item No	M 50119
规格 Size	1/2 "(13mm)
装箱数 Pcs/Carlon	6pcs
空载转速RPM Free Speed	7000
驱动尺寸 anvil size	1/2"
最大松动扭矩loosening torque	1756N.m
最大扭矩maximum torque	820n.m
工作范围working torque	50-580N.m
进气口尺寸air inter	1/4"
管子尺寸hose size	3/8"
最小耗气量consumption CFM	4CFM
长度length	183mm
机重 Single Weight	1.9KG

3/4"系列复合材料大扭力气扳机
Air Impact Wrench



货号 Item No	M 50121
规格 Size	3/4 "(19mm)
装箱数 Pcs/Carlon	4pcs
空载转速RPM Free Speed	5500
驱动尺寸 anvil size	3/4 "
最大扭矩maximum torque	2034N.m
工作范围working torque	271-1627N.m
进气口尺寸air inter	3/8 "
管子尺寸hose size	1/2 "
最小耗气量consumption CFM	7CFM
长度length	215MM
机重 Single Weight	3.3KG

1/2"系列工业级气扳机
Air Impact Wrench



货号 Item No	M 50114
装箱数 Pcs/Carlon	9pcs
重量 G.W.	24.40kg
工作压力 Air Pressure psi/bar	0.63MPa
空载转速 No-load Speed	≥6000r/min
负载耗气量Load Air Consumption	12L/S
拧紧扭矩 Tightening Torque	210N.m/2s
噪声(声功率级) Noise	≤103dB(A)
机重 Single Weight	2.6KG

- 结构合理先进,功率大,寿命长
- 主要用于汽车、工程机械、拖拉机等行业装配线上M14以下螺栓的装配和拆卸
- Reasonable and advanced structure, large power and long lifetime.
- Mainly used for assembling and disassembling of bolts under M14 in the assembling line of automobile, engineering machinery and tractor.

1"系列气动冲击扳手
Air Impact Wrench



货号 Item No	M50125
螺栓能力 Bolt Capacity	M42
最大扭矩 maximum torque	3200N.m
转速 REV	4800 RPM
进气口尺寸 air inter	1/2"
机重 Single Weight	9.92kg

- 双环结构,传动轴打击力匀称,震动更小
- 端盖整体热处理,耐冲击
- Double-ring structure for an even strike force on drive shaft and less vibration.
- Impact resistant integrated heat-treated end cap.

夹持类工具

Clamping Tools

钢丝钳、斜嘴钳、尖嘴钳	76-78
卡簧钳	78-80
迷你钳	80-81
大力钳	82-85
鲤鱼钳	85
扎线钳、胡桃夹	85
F夹	86
G字夹	87
Pliers	76-78
Snap Ring Pliers	78-80
Mini Pliers	80-81
Locking Pliers	82-85
Slip Joint Pliers	85
Tower Pliers / Carpenter Pincers	85
F-Clamps	86
G-Clamps	87



钢丝钳
Combination Pliers

NEW



货号 Item No	规格 Size	L(总长) length	H(口深) Opening Depth	C(开口量) Opening Capacity	装盒数 Pc/Box	装箱数 Pc/Carton	毛重 GW/CTN	单支重 NW/PC
M28111	160mm(6")	165mm	29mm	28mm	10pcs	60pcs	16.00kg	0.22kg
M28112	175mm(7")	180mm	33mm	34mm	10pcs	60pcs	20.00kg	0.28kg
M28113	200mm(8")	205mm	36mm	42mm	10pcs	60pcs	26.00kg	0.37kg

- 采用优质60CRV材质,整体热处理,刃口特殊二次处理,硬度更高,剪切更锋利
- 钳体精抛后发黑处理,美观大方,防锈效果更佳
- 专利人体工学设计环保手柄,握感更舒适
- Made of high-quality 60CRV steel, integral heat treated. With special secondary treatment of the cutting edge for higher hardness and sharper cutting.
- Precision polished and black phosphated body, good looking and better anti-rust performance.
- Patented ergonomic design handle for a comfortable grip.

德式省力钢丝钳
Power Saving Combination Pliers

NEW



货号 Item No	规格 Size	L(总长) length	H(口深) Opening Depth	C(开口量) Opening Capacity	装盒数 Pc/Box	装箱数 Pc/Carton	毛重 GW/CTN	单支重 NW/PC
M28456	160mm(6")	165mm	36mm	24mm	10pcs	60pcs	15.00kg	0.20kg
M28457	175mm(7")	185mm	39mm	27mm	10pcs	60pcs	21.00kg	0.28kg
M28458	200mm(8")	200mm	42mm	30mm	10pcs	60pcs	23.00kg	0.33kg

- 采用优质60CRV材质,整体热处理,刃口特殊二次处理,硬度更高,剪切更锋利
- 偏心设计,剪切更省力
- 钳体精抛后发黑处理,美观大方,防锈效果更佳
- 专利人体工学设计手柄,握感更舒适
- Made of high-quality 60CRV steel, integral heat treated. With special secondary treatment of the cutting edge for higher hardness and sharper cutting.
- Labor saving eccentric design.
- Precision polished and black phosphated body, good looking and better anti-rust performance.
- Patented ergonomic design handle for a comfortable grip.

斜嘴钳
Diagonal Cutting Pliers

NEW



货号 Item No	规格 Size	L(总长) length	H(口深) Opening Depth	C(开口量) Opening Capacity	装盒数 Pc/Box	装箱数 Pc/Carton	毛重 GW/CTN	单支重 NW/PC
M28142	160mm(6")	160mm	20mm	19mm	10pcs	60pcs	15.00kg	0.19kg
M28143	200mm(8")	190mm	26mm	32mm	10pcs	60pcs	22.00kg	0.30kg

- 采用优质60CRV材质,整体热处理,刃口特殊二次处理,硬度更高,剪切更锋利
- 钳体精抛后发黑处理,美观大方,防锈效果更佳
- 专利人体工学设计环保手柄,握感更舒适
- Made of high-quality 60CRV steel, integral heat treated. With special secondary treatment of the cutting edge for higher hardness and sharper cutting.
- Precision polished and black phosphated body, good looking and better anti-rust performance.
- Patented ergonomic design handle for a comfortable grip.

德式省力斜嘴钳
Power Saving Diagonal Cutting Pliers

NEW



货号 Item No	规格 Size	L(总长) length	H(口深) Opening Depth	C(开口量) Opening Capacity	装盒数 Pc/Box	装箱数 Pc/Carton	毛重 GW/CTN	单支重 NW/PC
M28466	160mm(6")	165mm	24mm	27mm	10pcs	60pcs	16.00kg	0.21kg
M28468	175mm(7")	175mm	25mm	28mm	10pcs	60pcs	20.00kg	0.27kg

- 采用优质60CRV材质,整体热处理,刃口特殊二次处理,硬度更高,剪切更锋利
- 偏心设计,剪切更省力
- 钳体精抛后发黑处理,美观大方,防锈效果更佳
- 专利人体工学设计手柄,握感更舒适
- Made of high-quality 60CRV steel, integral heat treated. With special secondary treatment of the cutting edge for higher hardness and sharper cutting.
- Labor saving eccentric design.
- Precision polished and black phosphated body, good looking and better anti-rust performance.
- Patented ergonomic design handle for a comfortable grip.

尖嘴钳
Long Nose Pliers

NEW



货号 Item No	规格 Size	L(总长) length	H(口深) Opening Depth	C(开口量) Opening Capacity	装盒数 Pc/Box	装箱数 Pc/Carton	毛重 GW/CTN	单支重 NW/PC
M28163	160mm(6")	165mm	51mm	48mm	10pcs	60pcs	13.00kg	0.16kg
M28164	200mm(8")	205mm	67mm	64mm	10pcs	60pcs	18.00kg	0.24kg

- 采用优质60CRV材质,整体热处理,刃口特殊二次处理,硬度更高,剪切更锋利
- 钳体精抛后发黑处理,美观大方,防锈效果更佳
- 专利人体工学设计环保手柄,握感更舒适
- Made of high-quality 60CRV steel, integral heat treated. With special secondary treatment of the cutting edge for higher hardness and sharper cutting.
- Precision polished and black phosphated body, good looking and better anti-rust performance.
- Patented ergonomic design handle for a comfortable grip.

德式省力尖嘴钳
Power Saving Long Nose Pliers

NEW



货号 Item No	规格 Size	L(总长) length	H(口深) Opening Depth	C(开口量) Opening Capacity	装盒数 Pc/Box	装箱数 Pc/Carton	毛重 GW/CTN	单支重 NW/PC
M28477	160mm(6")	160mm	50mm	45mm	10pcs	60pcs	11kg	0.165kg
M28478	200mm(8")	198mm	62mm	60mm	10pcs	60pcs	14.5kg	0.225kg

- 采用优质60CRV材质,整体热处理,刃口特殊二次处理,硬度更高,剪切更锋利
- 偏心设计,剪切更省力
- 钳体精抛后发黑处理,美观大方,防锈效果更佳
- 专利人体工学设计手柄,握感更舒适
- Made of high-quality 60CRV steel, integral heat treated. With special secondary treatment of the cutting edge for higher hardness and sharper cutting.
- Labor saving eccentric design.
- Precision polished and black phosphated body, good looking and better anti-rust performance.
- Patented ergonomic design handle for a comfortable grip.

工业级德式大头斜嘴钳
Diagonal Cutting Pliers

工业级

CR-V



货号 Item No	规格 Size	L(总长) length	H(口深) Opening Depth	C(开口量) Opening Capacity	装盒数 Pc/Box	装箱数 Pc/Carton	毛重 GW/CTN	单支重 NW/PC
M 28467	180mm(7")	183mm	21mm	14mm	5pcs	30pcs	10.00kg	0.300kg

- 采用优质 60CrV 钢锻造而成,整体热处理。
- 强度高,使用寿命长,省力省时,剪切材料硬度可达到 HRC45
- 性能超国外先进水平
- Body drop-forged with CRV, Heat Treatment
- High quality, hardness of the cutting material up to HRC45
- The function exceed the advanced World level

工业级日式钢丝钳
Combination Pliers

工业级

CR-V



货号 Item No	规格 Size	L(总长) length	H(口深) Opening Depth	C(开口量) Opening Capacity	装盒数 Pc/Box	装箱数 Pc/Carton	毛重 GW/CTN	单支重 NW/PC
M 28449	160mm(6")	165mm	28mm	32mm	5pcs	50pcs	15.10kg	0.270kg
M 28450	175mm(7")	190mm	32mm	37mm	5pcs	50pcs	19.50kg	0.360kg
M 28451	200mm(8")	225mm	36mm	39mm	5pcs	50pcs	26.40kg	0.500kg

- 采用优质 60CrV 钢锻造而成,整体热处理。
- 强度高,使用寿命长,省力省时,剪切材料硬度可达到 HRC45
- 性能超国外先进水平
- Body drop-forged with CRV, Heat Treatment
- High quality, hardness of the cutting material up to HRC45
- The function exceed the advanced World level

工业级日式斜嘴钳
Diagonal Cutting Pliers

工业级

CR-V



货号 Item No	规格 Size	L(总长) length	H(口深) Opening Depth	C(开口量) Opening Capacity	装盒数 Pc/Box	装箱数 Pc/Carton	毛重 GW/CTN	单支重 NW/PC
M 28463	160mm(6")	163mm	23mm	31mm	5pcs	50pcs	13.00kg	0.240kg

- 采用优质 60CrV 钢锻造而成,整体热处理。
- 强度高,使用寿命长,省力省时,剪切材料硬度可达到 HRC45
- 性能超国外先进水平
- Body drop-forged with CRV, Heat Treatment
- High quality, hardness of the cutting material up to HRC45
- The function exceed the advanced World level

工业级省力钢丝钳
Combination Pliers

工业级

CR-V



货号 Item No	规格 Size	L(总长) length	H(口深) Opening Depth	C(开口量) Opening Capacity	装盒数 Pc/Box	装箱数 Pc/Carton	毛重 GW/CTN	单支重 NW/PC
M 28455	225mm(9")	245mm	41mm	49mm	5pcs	30pcs	18.70kg	0.567kg

- 采用优质 60CrV 钢锻造而成,整体热处理。
- 强度高,使用寿命长,省力省时,剪切材料硬度可达到 HRC45
- 性能超国外先进水平
- Body drop-forged with CRV, Heat Treatment
- High quality, hardness of the cutting material up to HRC45
- The function exceed the advanced World level

专业级双色塑柄斜嘴钳
Diagonal Cutting Pliers

CR-V



货号 Item No	规格 Size	L(总长) length	H(口深) Opening Depth	C(开口量) Opening Capacity	装盒数 Pc/Box	装箱数 Pc/Carton	毛重 GW/CTN	单支重 NW/PC
M 28136	160mm(6")	165mm	22mm	22mm	6pcs	60pcs	14.50kg	0.217kg
M 28137	200mm(8")	202mm	28.8mm	22mm	6pcs	60pcs	17.74kg	0.279kg

- 优质铬钒钢锻造,钳口特殊热处理
- 根据人体工学设计的双材料手柄,使用舒适,手柄使用无毒材料,符合欧盟标准,剪切材料硬度可达到 HRC40
- 本品属于易耗品,不属于终身保用范围
- Body drop-forged, high frequency heat-treated jaws
- High quality, hardness of the cutting material up to HRC40
- No warranty as consumables

专业级双色塑柄尖嘴钳
Long Nose Pliers

CR-V



货号 Item No	规格 Size	L(总长) length	H(口深) Opening Depth	C(开口量) Opening Capacity	装盒数 Pc/Box	装箱数 Pc/Carton	毛重 GW/CTN	单支重 NW/PC
M 28155	160mm(6")	167mm	52mm	47mm	6pcs	60pcs	14.00kg	0.200kg
M 28156	200mm(8")	205mm	77mm	58mm	6pcs	60pcs	19.00kg	0.275kg

- 优质铬钒钢锻造,钳口特殊热处理
- 根据人体工学设计的双材料手柄,使用舒适,手柄使用无毒材料,符合欧盟标准,剪切材料 HRC40
- 本品属于易耗品,不属于终身保用范围
- Body drop-forged with CRV steel, high frequency heat-treated jaws
- High quality, hardness of the cutting material up to HRC40
- No warranty as consumables

专业级双色塑柄钢丝钳

Combination Pliers



CR-V

货号 Item No	规格 Size	L(总长) length	H(口深) Opening Depth	C(开口量) Opening Capacity	装盒数 Pc/Box	装箱数 Pc/Carton	毛重 GW/CTN	单支重 NW/PC
M28101	160mm(6")	165mm	28mm	23mm	6pcs	60pcs	15.20kg	0.220kg
M28102	175mm(7")	183mm	31mm	32mm	6pcs	60pcs	18.80kg	0.280kg
M28103	200mm(8")	208mm	35mm	37mm	6pcs	60pcs	26.60kg	0.433kg

- 优质铬钒钢锻造，钳口特殊热处理
- 根据人体工学设计的双材料手柄，使用更舒适，手柄使用无毒材料，符合欧盟标准，剪切材料硬度可达到 HRC40
- △ 本品属于易耗品，不属于终身保用范围
- Body drop-forged with CRV steel, high frequency heat-treated jaws
- High quality, hardness of the cutting material up to HRC40
- △ No warranty as consumables

工业级水口钳

Plastic Nippers



CR-V

货号 Item No	规格 Size	L(总长) length	H(口深) Opening Depth	C(开口量) Opening Capacity	装盒数 Pc/Box	装箱数 Pc/Carton	毛重 GW/CTN	单支重 NW/PC
M28188	125mm(5")	127mm	18mm	18mm	5pcs	50pcs	6.80kg	0.120kg
M28189	160mm(6")	157mm	20mm	21mm	5pcs	50pcs	9.60kg	0.180kg

- 采用优质 60CrV 钢锻造而成，整体热处理。
- 强度高，使用寿命长，省力省时
- 性能超国外先进水平
- Body drop-forged with CRV, Heat Treatment
- High quality, hardness of the cutting material up to HRC45
- The function exceed the advanced World level

专业级双色塑柄省力钳

Combination Pliers



CR-V

货号 Item No	规格 Size	L(总长) length	H(口深) Opening Depth	C(开口量) Opening Capacity	装盒数 Pc/Box	装箱数 Pc/Carton	毛重 GW/CTN	单支重 NW/PC
M28176	200mm(8")	204mm	51mm	45mm	6pcs	60pcs	23.94kg	0.367kg

- 优质铬钒钢锻造，钳口特殊热处理，特殊材料设计，省力 50%
- 根据人体工学设计的双材料手柄，使用舒适，手柄使用无毒材料，符合欧盟标准，剪切材料硬度可达到 HRC40
- △ 本品属于易耗品，不属于终身保用范围
- Body drop-forged with CRV steel, high frequency heat-treated jaws
- High quality, hardness of the cutting material up to HRC40
- △ No warranty as consumables

工业级斜嘴钳

Diagonal Cutting Pliers



工业级

CR-V

货号 Item No	规格 Size	L(总长) length	H(口深) Opening Depth	C(开口量) Opening Capacity	装盒数 Pc/Box	装箱数 Pc/Carton	毛重 GW/CTN	单支重 NW/PC
M28462	125mm(5")	128mm	15mm	7mm	5pcs	50pcs	5.60kg	0.100kg

- 采用优质 60CrV 钢锻造而成，整体热处理。
- 强度高，使用寿命长，省力省时，剪切材料硬度可达到 HRC45
- 性能超国外先进水平
- Body drop-forged with CRV, Heat Treatment
- High quality, hardness of the cutting material up to HRC45
- The function exceed the advanced World level

直嘴内卡簧钳

Straight Nose Internal Snap Ring Pliers



货号 Item No	规格 Size	尖端直径 Φ Jaw End Diameter	适用卡簧范围 D Snap Ring Range	总长 length	单支重 NW/PC
M28812	0.9x105mm	0.9	8-13	140	0.115kg
M28813	1.3x105mm	1.3	12-25	140	0.115kg
M28814	1.8x180mm	1.8	19-60	185	0.215kg
M28815	2.2x215mm	2.2	40-100	215	0.300kg
M28816	3.2x310mm	3.2	85-200	310	0.565kg

- 适应范围 8-200mm • 钢琴线钳头；不易变形。 • 头部角度特殊设计，夹持力更优
- 颜色快速识别；节约时间。 • 手柄采用耐磨防滑 PVC 材料。
- △ 本品属于易耗品，不属于终身保用范围
- Snap ring range 8-200mm • Piano wire tips: high distortion resistance.
- Long specially angled tips for optimum circlip holding.
- Identification colour code: saves time. • Grips in anti-slip granite PVC.
- △ No warranty as consumables

直嘴外卡簧钳

Straight Nose External Snap Ring Pliers



货号 Item No	规格 Size	尖端直径 Φ Jaw End Diameter	适用卡簧范围 D Snap Ring Range	总长 length	单支重 NW/PC
M28805	0.9x105mm	0.9	3-10	150	0.105kg
M28806	1.3x105mm	1.3	10-25	150	0.105kg
M28807	1.8x180mm	1.8	19-60	180	0.175kg
M28808	2.2x215mm	2.2	40-100	215	0.280kg
M28809	3.2x310mm	3.2	85-200	310	0.600kg

- 适应范围 3-200mm • 钢琴线钳头；不易变形。 • 头部角度特殊设计，夹持力更优
- 颜色快速识别；节约时间。 • 手柄采用耐磨防滑 PVC 材料。
- △ 本品属于易耗品，不属于终身保用范围
- Snap ring range 3-200mm • Piano wire tips: high distortion resistance.
- Long specially angled tips for optimum circlip holding.
- Identification colour code: saves time. • Grips in anti-slip granite PVC.
- △ No warranty as consumables

45°弯嘴内卡簧钳

45° Bent Nose Internal Snap Ring Pliers



货号 Item No	规格 Size	尖端直径 Φ Jaw End Diameter	适用卡簧范围 D Snap Ring Range	总长 length	单支重 NW/PC
M28826	0.9x105mm	0.9	8-13	140	0.115kg
M28827	1.3x105mm	1.3	12-25	140	0.115kg
M28828	1.8x180mm	1.8	19-60	180	0.215kg
M28829	2.2x215mm	2.2	40-100	215	0.312kg

- 适应范围 8-100mm • 钢琴线钳头；不易变形。 • 头部角度特殊设计，夹持力更优
- 颜色快速识别；节约时间。 • 手柄采用耐磨防滑 PVC 材料。
- △ 本品属于易耗品，不属于终身保用范围
- Snap ring range 8-100mm • Piano wire tips: high distortion resistance.
- Long specially angled tips for optimum circlip holding.
- Identification colour code: saves time. • Grips in anti-slip granite PVC.
- △ No warranty as consumables

45°弯嘴卡簧钳

45° Bent Nose External Snap Ring Pliers



货号 Item No	规格 Size	尖端直径 Φ Jaw End Diameter	适用卡簧范围 D Snap Ring Range	总长 length	单支重 NW/PC
M28819	0.9x105mm	0.9	3-10	145	0.105kg
M28820	1.3x105mm	1.3	10-25	145	0.105kg
M28821	1.8x180mm	1.8	19-60	175	0.175kg
M28822	2.2x215mm	2.2	40-100	215	0.280kg

- 适应范围 3-100mm • 钢琴线钳头；不易变形。 • 头部角度特殊设计，夹持力更优
- 颜色快速识别；节约时间。 • 手柄采用耐磨防滑 PVC 材料。
- △ 本品属于易耗品，不属于终身保用范围
- Snap ring range 3-100mm • Piano wire tips: high distortion resistance.
- Long specially angled tips for optimum circlip holding.
- Identification colour code: saves time. • Grips in anti-slip granite PVC.
- △ No warranty as consumables

90°弯嘴内卡簧钳

90° Bent Nose Internal Snap Ring Pliers



货号 Item No	规格 Size	尖端直径 Φ Jaw End Diameter	适用卡簧范围 D Snap Ring Range	总长 length	单支重 NW/PC
M28840	0.9x105mm	0.9	8-13	130	0.115kg
M28841	1.3x105mm	1.3	12-25	130	0.115kg
M28842	1.8x180mm	1.8	19-60	170	0.215kg
M28843	2.2x215mm	2.2	40-100	205	0.312kg
M28844	3.2x310mm	3.2	85-200	290	0.620kg

- 适应范围 8-200mm • 钢琴线钳头；不易变形。 • 头部角度特殊设计，夹持力更优
- 颜色快速识别；节约时间。 • 手柄采用耐磨防滑 PVC 材料。
- △ 本品属于易耗品，不属于终身保用范围
- Snap ring range 8-200mm • Piano wire tips: high distortion resistance.
- Long specially angled tips for optimum circlip holding.
- Identification colour code: saves time. • Grips in anti-slip granite PVC.
- △ No warranty as consumables

90°弯嘴卡簧钳

90° Bent Nose External Snap Ring Pliers



货号 Item No	规格 Size	尖端直径 Φ Jaw End Diameter	适用卡簧范围 D Snap Ring Range	总长 length	单支重 NW/PC
M28833	0.9x105mm	0.9	3-10	140	0.105kg
M28834	1.3x105mm	1.3	10-25	140	0.105kg
M28835	1.8x180mm	1.8	19-60	170	0.175kg
M28836	2.2x215mm	2.2	40-100	200	0.280kg
M28837	3.2x310mm	3.2	85-200	290	0.600kg

- 适应范围 3-100mm • 钢琴线钳头；不易变形。 • 头部角度特殊设计，夹持力更优
- 颜色快速识别；节约时间。 • 手柄采用耐磨防滑 PVC 材料。
- △ 本品属于易耗品，不属于终身保用范围
- Snap ring range 3-100mm • Piano wire tips: high distortion resistance.
- Long specially angled tips for optimum circlip holding.
- Identification colour code: saves time. • Grips in anti-slip granite PVC.
- △ No warranty as consumables

专业级日式穴用弯嘴卡簧钳

Snap Ring Pliers



货号 Item No	规格 Size	L(总长) length	尖端直径 Jaw End Diameter	卡簧范围 Snap Ring Range	装盒数 Pc/Box	装箱数 Pc/Carton	毛重 GW/CTN	单支重 NW/PC
M28716	150mm(5")	125mm	1.6mm	10-22mm	6pcs	60pcs	7.10kg	0.108kg
M28717	175mm(7")	170mm	1.7mm	19-60mm	6pcs	60pcs	12.00kg	0.183kg
M28718	230mm(9")	220mm	2.0mm	40-100mm	6pcs	60pcs	17.90kg	0.275kg

- 钳头经特殊热处理，使强度得到增强 • 复位弹簧确保操作平稳性
- 抛光处理，手柄带 PVC 护套 • 钳头防滑设计，可安全的夹持卡簧
- 选择与卡簧口直径最近的钳头 • 不要打磨卡簧钳头
- △ 本品属于易耗品，不属于终身保用范围
- With special heat treatment on the head, enhance the strength
- Spring restoration ensure smooth operation
- Anti Slip design on the head • Do not polish the head of pliers
- △ No warranty as consumables

专业级日式穴用直嘴卡簧钳

Snap Ring Pliers



货号 Item No	规格 Size	L(总长) length	尖端直径 Jaw End Diameter	卡簧范围 Snap Ring Range	装盒数 Pc/Box	装箱数 Pc/Carton	毛重 GW/CTN	单支重 NW/PC
M28711	150mm(5")	130mm	1.6mm	10-22mm	6pcs	60pcs	7.10kg	0.108kg
M28712	175mm(7")	180mm	1.8mm	19-60mm	6pcs	60pcs	12.00kg	0.183kg
M28713	230mm(9")	230mm	2.2mm	40-100mm	6pcs	60pcs	17.90kg	0.275kg

- 钳头经特殊热处理，使强度得到增强 • 复位弹簧确保操作平稳性
- 钳头防滑设计，可安全的夹持卡簧 • 抛光处理，手柄带 PVC 护套
- 选择与卡簧口直径最近的钳头 • 不要打磨卡簧钳头
- △ 本品属于易耗品，不属于终身保用范围
- With special heat treatment on the head, enhance the strength
- Spring restoration ensure smooth operation • Dipped with PVC handle
- Anti Slip design on the head • Do not polish the head of pliers
- △ No warranty as consumables

专业级日式轴用直嘴卡簧钳 Snap Ring Pliers

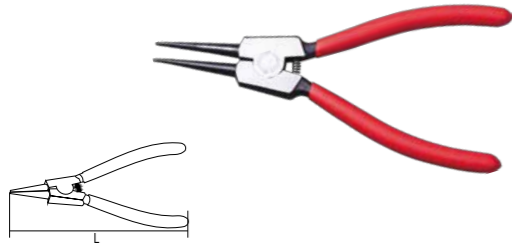

货号 Item No	规格 Size	L(总长) length	尖端直径 Jaw End Diameter	卡簧范围 Snap Ring Range	装盒数 Pc/Box	装箱数 Pc/Carton	毛重 GW/CTN	单支重 NW/PC
M 28721	150mm(5")	130mm	1.7mm	10-22mm	6pcs	60pcs	7.10kg	0.108kg
M 28722	175mm(7")	180mm	1.7mm	19-60mm	6pcs	60pcs	12.00kg	0.183kg
M 28723	230mm(9")	230mm	1.9mm	40-100mm	6pcs	60pcs	17.90kg	0.275kg

- 钳头经特殊热处理，使强度得到增强
- 复位弹簧确保操作平稳性
- 抛光处理，手柄带 PVC 护套
- 钳头防滑设计，可安全的夹持卡簧
- 选择与卡簧口直径最近的钳头
- 不要打磨卡簧钳头
- △ 本品属于易耗品，不属于终身保用范围
- With special heat treatment on the hand, enhance the strength
- Spring restoration ensure smooth operation
- Anti Slip design on the head
- Do not polish the head of pliers
- △ No warranty as consumables

专业级日式轴用弯嘴卡簧钳 Snap Ring Pliers

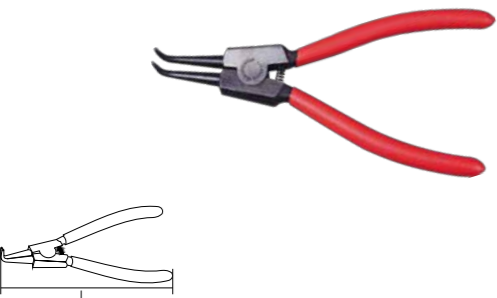

货号 Item No	规格 Size	L(总长) length	尖端直径 Jaw End Diameter	卡簧范围 Snap Ring Range	装盒数 Pc/Box	装箱数 Pc/Carton	毛重 GW/CTN	单支重 NW/PC
M28726	150mm(5")	125mm	1.7mm	10-22mm	6pcs	60pcs	7.10kg	0.108kg
M28727	175mm(7")	170mm	1.7mm	19-60mm	6pcs	60pcs	12.00kg	0.183kg
M28728	230mm(9")	215mm	2.0mm	40-100mm	6pcs	60pcs	17.90kg	0.275kg

- 钳头经特殊热处理，使强度得到增强
- 复位弹簧确保操作平稳性
- 抛光处理，手柄带 PVC 护套
- 钳头防滑设计，可安全的夹持卡簧
- 选择与卡簧口直径最近的钳头
- 不要打磨卡簧钳头
- △ 本品属于易耗品，不属于终身保用范围
- With special heat treatment on the hand, enhance the strength
- Spring restoration ensure smooth operation
- Anti Slip design on the head
- Do not polish the head of pliers
- △ No warranty as consumables

卡簧钳组套 4PCS Snap Ring Pliers Set



货号 Item No	规格 Size	装盒数 Pc/Box	装箱数 Pc/Carton	毛重 GW/CTN	每套重量 Weight Per Set
M 09251	4pcs	1pc	60pcs	9.00kg	0.26kg

- 本卡簧钳可以很方便的进行轴用功能或穴用功能的转换
- 使用范围:10-50mm
- 本组套有4种钳头，分别为:1mm-180°,1.5mm-180°,1.5mm-90°,1.5mm-45°
- This circlip pliers can be easily switched between internal and external use.
- Capacity: 10-50mm
- This set includes 4 heads below:1mm-180°,1.5mm-180°,1.5mm-90°,1.5mm-45°

迷你钢丝钳 Mini Combination Pliers



货号 Item No	规格 Size	L(总长) length	口深 Opening Depth	开口量 Opening Capacity	装盒数 Pc/Box	装箱数 Pc/Carton	毛重 GW/CTN	单支重 NW/PC
M 28631	115mm(4.5")	120mm	21.5 mm	8 mm	6pcs	60pcs	5.90kg	0.083kg

- 优质钢材锻造而成，整体热处理，双色注塑手柄
- △ 本品属于易耗品，不属于终身保用范围
- high quality steel,drop forged,whole body heat treatment,with bi-color dipped handle
- △ No warranty as consumables

迷你斜嘴钳 Mini Diagonal Cutting Pliers



货号 Item No	规格 Size	L(总长) length	口深 Opening Depth	开口量 Opening Capacity	装盒数 Pc/Box	装箱数 Pc/Carton	毛重 GW/CTN	单支重 NW/PC
M 28635	115mm(4.5")	110mm	14 mm	6 mm	6pcs	60pcs	7.00kg	0.100kg

- 优质钢材锻造而成，整体热处理，双色注塑手柄
- △ 本品属于易耗品，不属于终身保用范围
- high quality steel,drop forged,whole body heat treatment,with bi-color dipped handle
- △ No warranty as consumables

迷你尖嘴钳 Mini Long Nose Pliers



货号 Item No	规格 Size	L(总长) length	口深 Opening Depth	开口量 Opening Capacity	装盒数 Pc/Box	装箱数 Pc/Carton	毛重 GW/CTN	单支重 NW/PC
M 28639	115mm(4.5")	124mm	26.5 mm	10 mm	6pcs	60pcs	6.80kg	0.100kg

- 优质钢材锻造而成，整体热处理，双色注塑手柄
- △ 本品属于易耗品，不属于终身保用范围
- high quality steel,drop forged,whole body heat treatment,with bi-color dipped handle
- △ No warranty as consumables

迷你长嘴钳 Mini Needle Nose Pliers

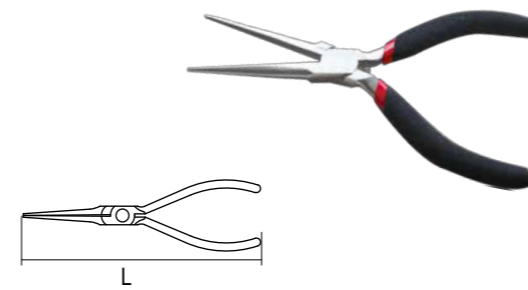

货号 Item No	规格 Size	L(总长) length	口深 Opening Depth	开口量 Opening Capacity	装盒数 Pc/Box	装箱数 Pc/Carton	毛重 GW/CTN	单支重 NW/PC
M 28643	115mm(4.5")	150mm	54.5mm	20mm	6pcs	60pcs	6.40kg	0.092kg

- 优质钢材锻造而成，整体热处理，双色注塑手柄
- △ 本品属于易耗品，不属于终身保用范围
- high quality steel,drop forged,whole body heat treatment,with bi-color dipped handle
- △ No warranty as consumables

迷你顶切钳 Mini End Cutting Nippers



货号 Item No	规格 Size	L(总长) length	口深 Opening Depth	开口量 Opening Capacity	装盒数 Pc/Box	装箱数 Pc/Carton	毛重 GW/CTN	单支重 NW/PC
M 28655	115mm(4.5")	105mm	7.5 mm	4 mm	6pcs	60pcs	7.00kg	0.100kg

- 优质钢材锻造而成，整体热处理，双色注塑手柄
- △ 本品属于易耗品，不属于终身保用范围
- high quality steel,drop forged,whole body heat treatment,with bi-color dipped handle
- △ No warranty as consumables

迷你弯嘴钳 Mini Bent nose pliers

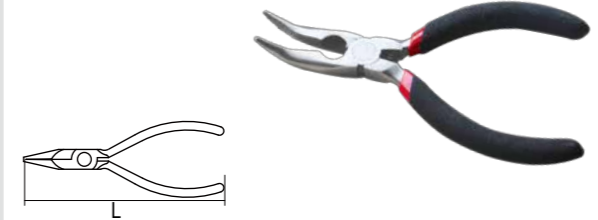

货号 Item No	规格 Size	L(总长) length	口深 Opening Depth	开口量 Opening Capacity	装盒数 Pc/Box	装箱数 Pc/Carton	毛重 GW/CTN	单支重 NW/PC
M 28647	115mm(4.5")	124mm	29 mm	9 mm	6pcs	60pcs	6.80kg	0.100kg

- 优质钢材锻造而成，整体热处理，双色注塑手柄
- △ 本品属于易耗品，不属于终身保用范围
- high quality steel,drop forged,whole body heat treatment,with bi-color dipped handle
- △ No warranty as consumables

迷你扁嘴钳 Mini Flat Nose Pliers



货号 Item No	规格 Size	L(总长) length	口深 Opening Depth	开口量 Opening Capacity	装盒数 Pc/Box	装箱数 Pc/Carton	毛重 GW/CTN	单支重 NW/PC
M 28651	115mm(4.5")	124mm	27mm	9mm	6pcs	60pcs	7.50kg	0.117kg

- 优质钢材锻造而成，整体热处理，双色注塑手柄
- △ 本品属于易耗品，不属于终身保用范围
- high quality steel,drop forged,whole body heat treatment,with bi-color dipped handle
- △ No warranty as consumables

扭线钳 Safety Wire Twisting Pliers



货号 Item No	规格 Size	装盒数 Pc/Box	装箱数 Pc/Carton	毛重 GW/CTN	单支重 NW/PC
M 40810	10"	1pc	60pcs	25.60kg	0.41kg

- 用于捻线和剪线，可捻丝φ0.5-1.6mm
- 斜角45°，头部细长
- 交叉夹取纹路更易夹取电线
- 顺时针或逆时针捻丝，可用手柄转换方向调节
- Used for twisting and trimming, it can be used for wires ofφ0.5-1.6mm
- Angled 45°, slender head
- Cross-clamping lines make it easier to pick up wires
- Clockwise or counterclockwise twisting, can be adjusted by handle

工业级圆口带刃大力钳
Curved Jaw Locking Pliers

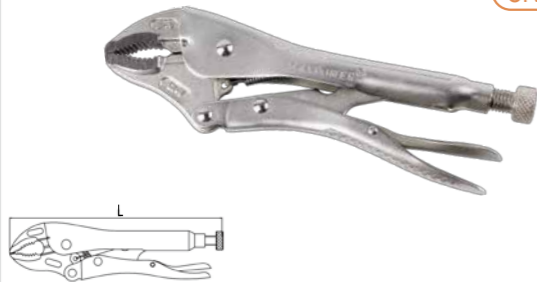

货号 Item No	规格 Size	L(总长) length	喉深 Opening Depth	开口量MM Opening Capacity	装盒数 Pcs/Box	装箱数 Pcs/Carton	毛重 GW/CTN	单支重 NW/PC
M 29000	113mm(4")	113 mm	20mm	20mm	6pcs	72pcs	8.60kg	0.096kg
M 29001	140mm(5")	137 mm	25mm	28.7mm	6pcs	48pcs	8.60kg	0.152kg
M 29002	180mm (7")	185 mm	33mm	38.1mm	6pcs	48pcs	17.00kg	0.323kg
M 29003	220mm (10")	225 mm	40mm	47.8mm	6pcs	36pcs	19.20kg	0.500kg
M 29004	255mm(12")	255 mm	45mm	55mm	6pcs	24pcs	17.20kg	0.657kg

- 钳口铬钒钢锻造, 韧性好
- 手柄钢板冲压, 整支热处理, 钳口硬度可达到HRC45-55
- 通过螺栓调整, 可夹持不同尺寸
- 产品夹持性能超过美标, 属于万能夹具, 可夹持多棱体等产品
- △本品刃口部位易损耗, 刃口部位不属于终身保用范围
- Drop forged CRV steel jaws, good toughness
- Punched steel plate handle, heat treated, jaw hardness HRC45-55
- The product can clamp different sizes through adjusting the screw
- The clamping performance exceeds ANSI standard. The product can clamp prism objects so it can be called "omnipotent clamp"
- △ The cutting edges are consumption goods, excluded in lifetime warranty

尖嘴带刃塑柄大力钳
Long Nose Locking Pliers



货号 Item No	规格 Size	L(总长) length	喉深 Opening Depth	开口量MM Opening Capacity	装盒数 Pcs/Box	装箱数 Pcs/Carton	毛重 GW/CTN	单支重 NW/PC
M 29123	165mm(6")	165mm	52mm	50mm	6pcs	48pcs	9.80kg	0.179kg
M 29124	220mm(9")	216mm	64mm	70mm	6pcs	36pcs	15.00kg	0.394kg

- 专利产品 ZL200330109826.4, ZL200430047753.5
- 钳口铬钒钢锻造, 韧性好
- 手柄钢板冲压, 整支热处理, 钳口硬度可达到HRC45-55
- 通过螺栓调整, 可夹持不同尺寸
- TPR手柄, 握持更舒服
- 产品夹持性能超过美标, 属于万能夹具, 可夹持多棱体等产品
- △本品刃口部位易损耗, 刃口部位不属于终身保用范围
- Patent products ZL200330109826.4, ZL200430047753.5
- Drop forged CRV steel jaws, good toughness
- Punched steel plate handle, heat treated, jaw hardness HRC45-55
- The product can clamp different sizes through adjusting the screw
- TPR handle makes gripping comfortable
- The clamping performance exceeds ANSI standard. The product can clamp prism objects so it can be called "omnipotent clamp"
- △ The cutting edges are consumption goods, excluded in lifetime warranty

工业级直口大力钳
Straight Jaw Locking Pliers



货号 Item No	规格 Size	L(总长) length	喉深 Opening Depth	开口量MM Opening Capacity	装盒数 Pcs/Box	装箱数 Pcs/Carton	毛重 GW/CTN	单支重 NW/PC
M 29025	180mm (7")	185mm	30mm	38.1mm	6pcs	48pcs	19.00kg	0.373kg
M 29026	220mm(10")	225mm	31mm	47.8mm	6pcs	36pcs	20.50kg	0.527kg
M 29027	255mm (12")	255mm	35mm	55mm	6pcs	24pcs	17.43kg	0.684kg

- 钳口铬钒钢锻造, 韧性好
- 手柄钢板冲压, 整支热处理, 钳口硬度可达到HRC45-55
- 通过螺栓调整, 可夹持不同尺寸
- 产品夹持性能超过美标, 属于万能夹具, 可夹持多棱体等产品
- Drop forged CRV steel jaws, good toughness
- Punched steel plate handle, heat treated, jaw hardness HRC45-55
- The product can clamp different sizes through adjusting the screw
- The clamping performance exceeds ANSI standard. The product can clamp prism objects so it can be called "omnipotent clamp"

双档位尖嘴大力钳
2 Position Long Nose Locking Pliers



货号 Item No	规格 Size	L(总长) length	开口量MM Opening Capacity	装盒数 Pcs/Box	装箱数 Pcs/Carton	毛重 GW/CTN	单支重 NW/PC
M29189	220mm(9")	220mm	80mm	6pcs	60pcs	24.60kg	0.393kg

- 两档位调节, 可迅速增大开口量
- 优质钢锻造, 韧性好
- 适合小零件的夹持及狭小空间使用
- Drop forged CRV, good toughness
- Two-step jaw positions for a wider jaws opening.
- Suitable for clamping small parts and working in narrow spaces

工业级尖嘴带刃大力钳
Long Nose Locking Pliers



货号 Item No	规格 Size	L(总长) length	喉深 Opening Depth	开口量MM Opening Capacity	装盒数 Pcs/Box	装箱数 Pcs/Carton	毛重 GW/CTN	单支重 NW/PC
M 29013	135mm (5")	133 mm	41mm	32mm	6pcs	48pcs	6.20kg	0.105kg
M 29014	165mm (6")	165 mm	52mm	50mm	6pcs	36pcs	7.00kg	0.169kg
M 29015	220mm (9")	216 mm	64mm	70mm	6pcs	36pcs	14.20kg	0.361kg

- 尖嘴设计, 适合狭窄空间
- 钳口铬钒钢锻造, 韧性好
- 手柄钢板冲压, 整支热处理, 钳口硬度可达到HRC45-55
- 通过螺栓调整, 可夹持不同尺寸
- 产品夹持性能超过美标, 属于万能夹具, 可夹持多棱体等产品
- △本品刃口部位易损耗, 刃口部位不属于终身保用范围
- Long nose design suitable for narrow space
- Drop forged CRV steel jaws, good toughness
- Punched steel plate handle, heat treated, jaw hardness HRC45-55
- The clamping performance exceeds ANSI standard. The product can clamp prism objects so it can be called "omnipotent clamp"
- △ The cutting edges are consumption goods, excluded in lifetime warranty

工业级平板金属夹钳
Locking Sheet Metal Clamp

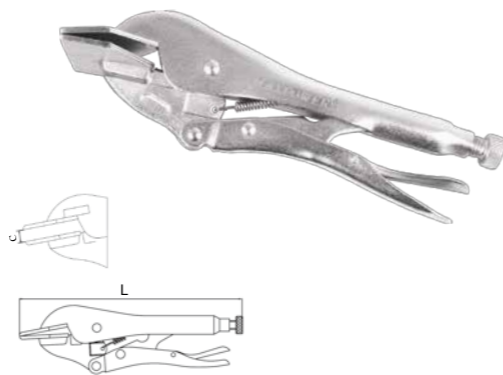

货号 Item No	规格 Size	L(总长) length	C(开口量MM) Opening Capacity	装盒数 Pcs/Box	装箱数 Pcs/Carton	毛重 GW/CTN	单支重 NW/PC
M 29251	200mm(8")	197 mm	12.7mm	3pcs	24pcs	14.00kg	0.486kg
M 29252	250mm(10")	248 mm	15mm	2pcs	16pcs	12.80kg	0.669kg

- 钳口优质钢锻造, 韧性好
- 手柄钢板冲压, 整支热处理, 钳口硬度可达到HRC35-45
- 通过螺栓调整, 可夹持铁板、折弯板材等
- Drop forged CRV steel jaws, good toughness
- Punched steel plate handle, heat treated, jaw hardness HRC35-45
- The product can clamp iron plate and bended plate through adjusting the screw

双档位圆口大力钳
2 Position Curved Jaw Locking Pliers



货号 Item No	规格 Size	L(总长) length	C(开口量MM) Opening Capacity	装盒数 Pcs/Box	装箱数 Pcs/Carton	毛重 GW/CTN	单支重 NW/PC
M29181	220mm(10")	225mm	60mm	6pcs	48pcs	25.10kg	0.504kg

- 两档位调节, 可迅速增大开口量
- 优质钢锻造, 韧性好
- Drop forged CRV, good toughness
- Two-step jaw positions for a wider jaws opening.

四档位大开口大力钳
4 Position Locking Pliers



货号 Item No	规格 Size	L(总长) length	C(开口量MM) Opening Capacity	装盒数 Pcs/Box	装箱数 Pcs/Carton	毛重 GW/CTN	单支重 NW/PC
M29185	250mm(10")	263mm	100mm	6pcs	36pcs	24.00kg	0.632kg

- 4档位调节, 可迅速增大开口量
- 优质钢锻造, 韧性好
- Drop forged CRV, good toughness
- Four-step jaw positions for a wider jaws opening.

超大鳄鱼嘴大力钳
Extra Large Crocodile Jaw Locking Plier

专利



货号 Item No	规格 Size	L(总长) length	开口量MM Opening Capacity	装盒数 Pc/Box	装箱数 Pc/Carton	毛重 GW/CTN	单支重 NW/PC
M 29050	250mm (10")	250mm	65mm	6pcs	36pcs	20.40kg	0.525kg

- 产品专利号: ZL2013201042144
- 手柄钢板冲压, 整支热处理, 钳口硬度可达到HRC45-55
- 通过螺栓调整, 可夹持不同尺寸
- 属于万能夹具, 可夹持多棱体等产品
- Patent products ZL2013201042144
- Drop forged CRV steel jaws, good toughness
- Punched steel plate handle, heat treated, jaw hardness HRC45-55
- The product can clamp different sizes through adjusting the screw
- The product can clamp prism objects so it can be called "omnipotent clamp"

工业级 C 型夹钳
Locking C-Clamp

工业级

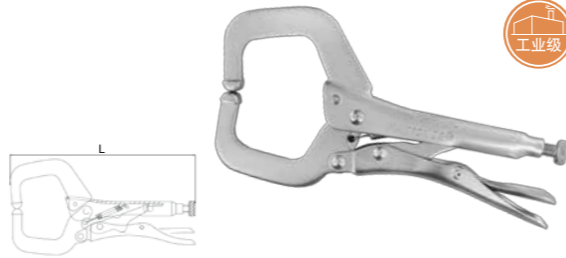

货号 Item No	规格 Size	L(总长) length	喉深 Opening Depth	开口量MM Opening Capacity	装盒数 Pc/Box	装箱数 Pc/Carton	毛重 GW/CTN	单支重 NW/PC
M 29217	150mm (6")	162mm	30mm	50mm	6pcs	72pcs	17.30kg	0.210kg
M 29218	228mm (9")	245mm	64mm	76mm	6pcs	24pcs	14.86kg	0.525kg
M 29219	280mm (11")	275mm	58mm	90mm	6pcs	24pcs	19.50kg	0.760kg
M 29220	350mm (14")	342mm	120mm	110mm	4pcs	24pcs	22.80kg	0.913kg
M 29221	450mm (18")	460mm	240mm	210mm	4pcs	16pcs	25.62kg	1.384kg

- 适用于木工、钳工、维修工专业夹持
- 手柄钢板冲压, 整支热处理, 钳口硬度可达到HRC38-48
- 通过螺栓调整, 可夹持不同尺寸, 性能超美标
- It is suitable for professional carpenter and professional decoration working
- Punched steel plate handle, heat treated, jaw hardness HRC38-48
- The product can clamp different sizes through adjusting the screw
- The clamping performance exceeds ANSI standard

滑杆大力钳
Sliding Arm Locking C-clamp

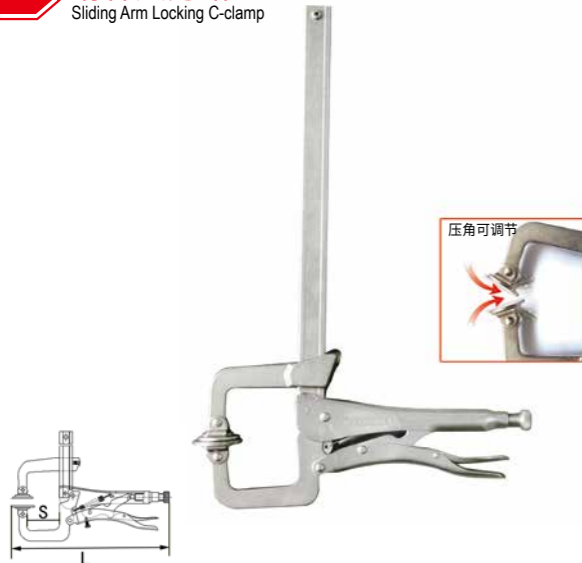

货号 Item No	规格 Size	L(总长) length	开口量MM Opening Capacity	装盒数 Pc/Box	装箱数 Pc/Carton	毛重 GW/CTN	单支重 NW/PC
M 29279	305mm (12")	296mm	305mm	2pcs	12pcs	20.50kg	1.496kg
M 29280	458mm (18")	296mm	458mm	2pcs	12pcs	23.00kg	1.691kg
M 29281	610mm (24")	296mm	610mm	2pcs	12pcs	23.80kg	1.825kg

- 集F夹、C字夹、C型钳为一体的一种万能大力钳, 适用于工装夹具、装备、焊接、
- 汽车制造业、木工、加工业、家装及工业维修等场合使用
- 性能强大、免调理、快速夹持, 夹持范围大, 性价比高
- Omnipotent locking pliers with the function of F clamp, C clamp and locking C clamp, suitable for fixing, clamping, welding, automobile manufacturing, carpentry, machining, household and industry maintenance
- Powerful functions, without adjustment, quick clamping, large working capacity, good value

工业级旋转压脚 C 型夹钳
Locking C-Clamp With Swivel Pads

工业级



货号 Item No	规格 Size	L(总长) length	喉深 Opening Depth	开口量MM Opening Capacity	装盒数 Pc/Box	装箱数 Pc/Carton	毛重 GW/CTN	单支重 NW/PC
M 29233	125mm (5")	136mm	20mm	38mm	6pcs	72pcs	14.21kg	0.150kg
M 29234	150mm (6")	180mm	38mm	50mm	6pcs	48pcs	14.00kg	0.254kg
M 29235	228mm (9")	250mm	57mm	80mm	6pcs	24pcs	15.50kg	0.581kg
M 29236	280mm (11")	280mm	57mm	90mm	6pcs	24pcs	20.30kg	0.795kg
M 29237	350mm (14")	350mm	125mm	110mm	4pcs	16pcs	16.20kg	0.940kg
M 29238	450mm (18")	460mm	236mm	210mm	4pcs	16pcs	23.50kg	1.384kg
M 29239	600mm (24")	620mm	390mm	340mm	2pcs	12pcs	24.00kg	1.748kg

- 适用于木工、钳工、维修工专业夹持
- 手柄钢板冲压, 整支热处理, 钳口硬度可达到HRC38-48
- 通过螺栓调整, 可夹持不同尺寸, 性能超美标
- It is suitable for professional carpenter and professional decoration working
- Punched steel plate handle, heat treated, jaw hardness HRC38-48
- The product can clamp different sizes through adjusting the screw
- The clamping performance exceeds ANSI standard

链条大力钳
Chain Locking Pliers

强夹持
CR-V

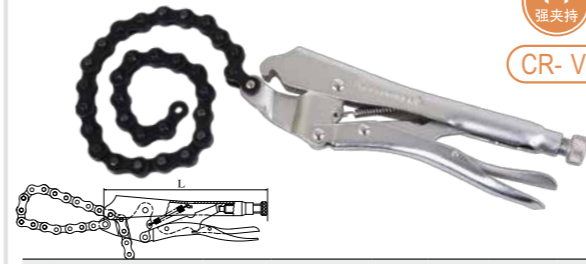

货号 Item No	规格 Size	L(总长) length	夹持范围 Clamping Capacity	装盒数 Pc/Box	装箱数 Pc/Carton	毛重 GW/CTN	单支重 NW/PC
M 29273	500mm (20")	230mm	10-145mm	6pcs	36pcs	26.50kg	0.709kg

- 链条长度500mm
- 手柄钢板冲压, 整支热处理, 钳口硬度可达到HRC35-45
- 通过螺栓调整, 可夹持不同尺寸
- 可夹持多种形状的物体, 如柱体、棱体、多边形体、管道等
- Chain length 500mm
- Punched steel plate handle, heat treated, hardness HRC35-45
- The product can clamp different sizes through adjusting the screw
- The product can clamp objects with different shapes, such as cylinder, prism, multilateral body and pipes, etc.

焊接大力钳
Locking Welding Clamp

强夹持



货号 Item No	规格 Size	L(总长) length	喉深 Opening Depth	C(夹持范围) Clamping Capacity	装盒数 Pc/Box	装箱数 Pc/Carton	毛重 GW/CTN	单支重 NW/PC
M 29258	230mm (9")	230mm	60mm	0-65mm	3pcs	24pcs	15.10kg	0.549kg
M 29259	250mm (10")	266mm	76mm	0-85mm	2pcs	16pcs	14.00kg	0.775kg

- 钳嘴为"U"形, 钳嘴中间为空的, 可进行焊接、铆接等操作
- 手柄钢板冲压, 整支热处理, 钳口硬度可达到HRC40-48
- 通过螺栓调整, 可夹持不同尺寸
- 夹持两个焊管, 可自动找中
- U shaped can be used for welding riveting
- Punched steel plate handle, heat treated, jaw hardness HRC40-48
- The product can clamp different sizes through adjusting the screw
- The product can clamp two welded pipes and it can automatically realize centering

胡桃钳
Carpenter Pincers



货号 Item No	规格 Size	L(总长) length	开口量 Opening Capacity	装盒数 Pc/Box	装箱数 Pc/Carton	毛重 GW/CTN	单支重 NW/PC
M 29384	200mm (8")	205mm	19mm	6pcs	48pcs	17.76kg	0.37kg
M 29386	250mm (10")	250mm	21mm	6pcs	48pcs	24.00kg	0.50kg

- 优质高碳钢锻造, 整支热处理, 刃口高频处理, 剪切硬度可达到 HRC40
- 本品属于易耗品, 不属于终身保用范围
- High quality carbon steel, drop forged, whole body heat treatment, high frequency heat-treated jaws, hardness of the cutting material up to HRC40
- No warranty as consumables

桌上型大力钳
Bench Clamp



货号 Item No	规格 Size	L(总长) length	喉深 Opening Depth	夹持高度 Clamping Capacity	装盒数 Pc/Box	装箱数 Pc/Carton	毛重 GW/CTN	单支重 NW/PC
M 29266	280mm (11")	283mm	92mm	0-100mm	4 pcs	24pcs	16.50kg	0.660kg
M 29267	350mm (14")	366mm	155mm	0-100mm	6 pcs	24pcs	17.80kg	0.710kg

- 可直接安装在工作台上, 实现快速装夹
- 尾部螺栓调节, 适应于不同高度夹紧定位
- 手柄钢板冲压, 整支热处理
- The product can be assembled on the workbench which can realize quick clamping adjusting the end screw
- Punched steel plate handle, heat treated

工业级鲤鱼钳
Slip Joint Pliers

工业级
CR-V



货号 Item No	规格 Size	L(总长) length	喉深 Opening Depth	开口量 Opening Capacity	装盒数 Pc/Box	装箱数 Pc/Carton	毛重 GW/CTN	单支重 NW/PC
M 29307	150mm (6")	160mm	29mm	25mm	6pcs	96pcs	24.86kg	0.240kg
M 29308	200mm (8")	205mm	33mm	28mm	6pcs	60pcs	18.00kg	0.267kg
M 29309	250mm (10")	245mm	41mm	32mm	6pcs	48pcs	23.00kg	0.440kg

- 铬钒钢锻造, 表面镀铬, 剪切硬度可达到 HRC
- 本品刃口部位易损耗, 刃口部位不属于终身保用范围, 其它属于终身保用范围
- drop forged with CRV steel, hardness of the cutting material up to HRC40
- They're consumption goods, excluded in lifetime warranty

扎线钳
Tower Pliers



货号 Item No	规格 Size	L(总长) length	开口量 Opening Capacity	装盒数 Pc/Box	装箱数 Pc/Carton	毛重 GW/CTN	单支重 NW/PC
M 29376	225mm (9")	229mm	23mm	6pcs	48pcs	20.50kg	0.390kg
M 29377	250mm (10")	250mm	23mm	6pcs	48pcs	22.40kg	0.430kg

- 优质高碳钢锻造, 整支热处理, 刃口高频处理
- 磷化处理沾塑柄, 镀锌处理, 剪切硬度可达到 HRC40
- 本品属于易耗品, 不属于终身保用范围
- Drop forged with high-carbon steel, body heat treatment
- Black phosphated with dipped handle, cutting hardness can be HRC40
- No warranty as consumables

工业级三件套 F 夹 F Clamp



货号 Item No	规格(LxH) Size	导轨 Rail	装盒数 Pc/Box	装箱数 Pc/Carton	毛重 GW/CTN	单支重 NW/PC
M30332	200x140mm	29.7x14.3mm	2pcs	8pcs	23.20kg	2.80kg
M30333	250x140mm	29.7x14.3mm	2pcs	8pcs	24.10kg	2.90kg
M30334	300x140mm	29.7x14.3mm	2pcs	8pcs	25.80kg	2.88kg
M30335	400x140mm	29.7x14.3mm	2pcs	6pcs	21.40kg	3.22kg
M30336	500x140mm	29.7x14.3mm	2pcs	6pcs	24.00kg	3.48kg
M30337	600x140mm	29.7x14.3mm	2pcs	6pcs	25.20kg	3.87kg
M30338	800x140mm	29.7x14.3mm	2pcs	4pcs	20.80kg	4.40kg
M30339	1000x140mm	29.7x14.3mm	2pcs	4pcs	23.00kg	5.02kg
M30340	1200x140mm	29.7x14.3mm	2pcs	4pcs	25.60kg	5.60kg

- 表面特殊热处理, 反复使用不变形、无压痕
- 夹紧力0-1250kg, 适用于金属行业, 各种物体的夹持
- Heat-treated, no deformation or pressed mark after repeated use
- Teasile strength 0-25kg, widely used Teasile strength 0-1250kg

重型 F 夹 F Clamp

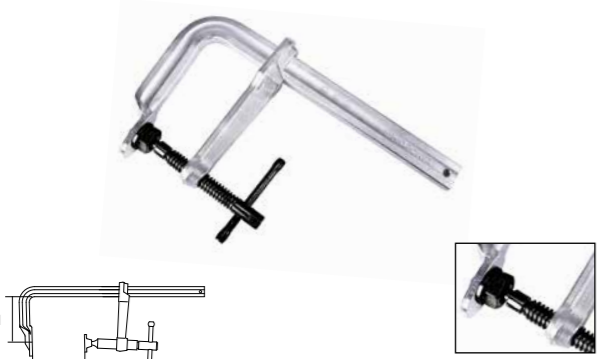

货号 Item No	规格(LxH) Size	导轨 Rail	装盒数 Pc/Box	装箱数 Pc/Carton	毛重 GW/CTN	单支重 NW/PC
M30370	300x180mm	42.1x19.1mm	2pcs	4pcs	24.00kg	5.80kg
M30371	400x180mm	42.1x19.1mm	2pcs	4pcs	27.00kg	6.40kg
M30372	500x180mm	42.1x19.1mm	2pcs	4pcs	29.50kg	6.85kg
M30373	600x180mm	42.1x19.1mm	/	2pcs	16.50kg	7.35kg

- 采用合金钢材, 表面特殊处理, 反复使用无压痕, 不变形
- 本品属于易耗品, 不属于终身保用范围
- Made of alloy steel with special surface treatment. Repeated use will not produce indentation and will not deform.
- No warranty as consumables

专业级 F 夹 F Clamp

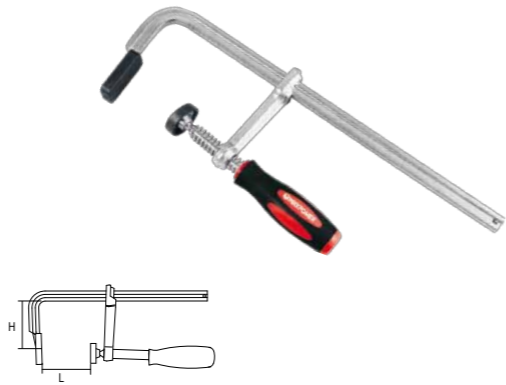

货号 Item No	规格(LxH) Size	导轨 Rail	装盒数 Pc/Box	装箱数 Pc/Carton	毛重 GW/CTN	单支重 NW/PC
M30121	160x80mm	15.5x7.5mm	4pcs	24pcs	15.80kg	0.600kg
M30122	200x80mm	15.5x7.5mm	4pcs	24pcs	17.00kg	0.650kg
M30123	250x80mm	15.5x7.5mm	4pcs	24pcs	18.50kg	0.700kg
M30124	300x80mm	15.5x7.5mm	4pcs	24pcs	19.30kg	0.750kg
M30125	450x80mm	15.5x7.5mm	4pcs	24pcs	21.80kg	0.800kg
M30126	600x80mm	15.5x7.5mm	4pcs	16pcs	17.40kg	1.000kg
M30127	800x80mm	15.5x7.5mm	2pcs	16pcs	20.80kg	1.200kg
M30128	900x80mm	15.5x7.5mm	2pcs	16pcs	21.50kg	1.230kg
M30129	1000x80mm	15.5x7.5mm	2pcs	16pcs	22.10kg	1.270kg
M30130	1200x80mm	15.5x7.5mm	2pcs	16pcs	29.00kg	1.700kg

- 表面特殊热处理, 反复使用不变形、无压痕
- 钳口带塑料压脚, 不伤物体表面, 适用于木工等行业
- 夹紧范围0-250kg
- Special heat-treated, no deformation or pressed mark after repeated use.
- With plastic pads to protect clamped surface.
- Clamping force range 0-25kgs

棘轮 F 夹 Ratcheting F Clamp

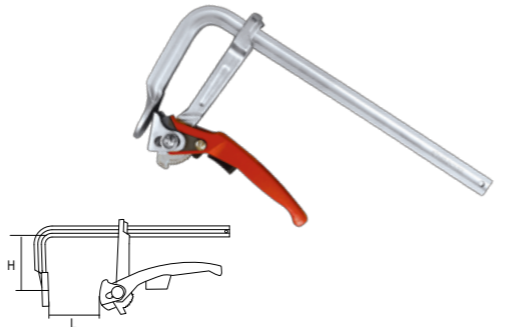

货号 Item No	规格(LxH) Size	导轨 Rail	装盒数 Pc/Box	装箱数 Pc/Carton	毛重 GW/CTN	单支重 NW/PC
M30453	200x140mm	25x12mm	2pcs	10pcs	24.00kg	2.300kg
M30454	300x140mm	25x12mm	2pcs	10pcs	25.80kg	2.450kg
M30455	400x140mm	25x12mm	2pcs	8pcs	24.30kg	2.870kg
M30456	500x140mm	25x12mm	2pcs	8pcs	26.20kg	3.100kg
M30457	600x140mm	25x12mm	2pcs	8pcs	28.70kg	3.370kg

- 表面特殊热处理, 反复使用不变形、无压痕
- 红色喷漆合金手柄, 轻便耐用
- Heat-treated, no deformation or pressed mark after repeated use
- Red painted zinc alloy steel handle, light and durable

工业级 G 型夹 G Clamp



货号 Item No	规格 Size	开口量(O) Opening Capacity	喉深(S) Throat Depth	装盒数 Pc/Box	装箱数 Pc/Carton	毛重 GW/CTN	单支重 NW/PC
M30661	40mm (1.5")	40mm	40mm	12pcs	96pcs	19.00kg	0.200kg
M30662	60mm (2")	60mm	55mm	6pcs	48pcs	22.00kg	0.330kg
M30663	80mm (3")	80mm	65mm	6pcs	24pcs	22.80kg	0.880kg
M30664	100mm (4")	100mm	65mm	6pcs	24pcs	28.00kg	1.170kg
M30665	120mm (5")	120mm	85mm	6pcs	18pcs	25.50kg	1.420kg
M30666	150mm (6")	150mm	95mm	6pcs	12pcs	28.00kg	2.330kg
M30667	200mm (8")	200mm	105mm	2pcs	8pcs	25.50kg	3.190kg
M30668	250mm (10")	250mm	115mm	1pc	6pcs	28.00kg	4.700kg
M30669	300mm (12")	300mm	115mm	1pc	4pcs	23.00kg	5.750kg

- 锻造钳体, 材质合金钢, 整支热处理
- T形旋转手柄提供更大扭矩和紧固力
- 加持力超过国外先进水平, 使用寿命超铸造产品10倍以上
- 钳口花纹, 便于夹紧
- Drop forged body, alloy steel, heat-treated
- T grip with greater torque and clamping force.
- Using life can be 10 times longer than cast items.
- Knurled jaws for easy clamping.

重型 G 型夹 G Clamp



货号 Item No	规格 Size	开口量(O) Opening Capacity	喉深(S) Throat Depth	装盒数 Pc/Box	装箱数 Pc/Carton	毛重 GW/CTN	单支重 NW/PC
M30650	2"	60mm	47mm	2pcs	8pcs	15.50kg	1.74kg
M30652	4"	115mm	74mm	2pcs	4pcs	19.50kg	4.56kg

- 框架、丝杠采用45#钢材
- 整体热处理, 表面磷化处理
- Made of #45 carbon steel.
- Full body heat-treated. Black phosphate finished.

可换头 G 型夹 G Clamp



货号 Item No	规格 Size	喉深(S) Throat Depth	装盒数 Pc/Box	装箱数 Pc/Carton	毛重 GW/CTN	单支重 NW/PC
M30673	80x65mm	65mm	6pcs	18pcs	18.64kg	0.98kg
M30674	100x65mm	65mm	6pcs	18pcs	22.24kg	1.18kg
M30675	120x85mm	85mm	6pcs	12pcs	21.16kg	1.68kg
M30676	150x95mm	95mm	6pcs	12pcs	28.36kg	2.28kg
M30677	200x105mm	105mm	2pcs	6pcs	21.28kg	3.38kg
M30678	250x115mm	115mm	1pc	4pcs	20.00kg	4.74kg

- 锻造钳体
- 带V型、圆型压脚, 可加紧不同工件, 主要用于圆形、方形钢管夹紧焊接
- Drop forged body
- With V-shaped and round-shaped pad to clamp on different types of round and square shaped work pieces for welding or woodworking jobs.

塑料快速棘轮 F 夹 Plastic quick ratchet F clamp



货号 Item No	L	H	导轨 Guide	装盒数 Pc/Box	装箱数 Pc/Carton	毛重 GW/CTN	单支重 NW/PC
M30790	0-155mm	72mm	19x6mm	6pcs	24pcs	14.3kg	0.54kg
M30791	0-310mm	72mm	19x6mm	6pcs	24pcs	17.6kg	0.67kg
M30792	0-460mm	72mm	19x6mm	6pcs	12pcs	10.5kg	0.75kg
M30793	0-610mm	72mm	19x6mm	6pcs	12pcs	12.0kg	0.88kg

- 滑杆A3钢发黑色氧化处理, 防止生锈, 主体黑色尼龙, 坚固耐用, 不变形
- 带倒车按钮, 可快速调节夹持距离
- 快速拆卸旋钮, 使拆卸更方便
- 可反装设计, 能反推固定位置
- The sliding rod A3 steel has black oxidation treatment to prevent rusting, and the main body is black nylon, which is firm and durable without deformation.
- With reverse button, the clamping distance can be adjusted quickly
- Quickly remove the knob to make the removal more convenient
- Reversible design, able to reverse the fixed position